



STAFF REPORT

DUTY EVASION:

**HARMING U.S. INDUSTRY AND AMERICAN
WORKERS**

Prepared for Senator Ron Wyden

November 8, 2010

Table of Contents

Introduction	5
Part I: Email Correspondence Showcasing Companies’ Willingness to Evade AD/CV Duties	7
Certain Steel Nails from China	9
Companies Willing to Evade U.S. AD/CV Duties on Steel Nails.	10
Certain Lined Paper School Supplies from China	19
Companies Willing to Evade U.S. AD/CV Duties on Paper Products.....	20
Light-Walled Rectangular Pipe and Tube from China	27
Companies Willing to Evade U.S. AD/CV Duties on Light-Walled Rectangular Pipe and Tube.....	28
Uncovered Innersprings Units from China	31
Companies Willing to Evade U.S. AD/CV Duties on Uncovered Innersprings Units.	32
Natural Bristle Paint Brushes from China	35
Companies Willing to Evade U.S. AD/CV Duties on Natural Bristle Paint Brushes	36
Oil Country Tubular Goods (OCTG) from China	41
Companies Willing to Evade U.S. AD/CV Duties on OCTG from China Company	42
Diamond Sawblades from China	45
Companies Willing to Evade U.S. AD/CV Duties on Diamond Sawblades from China.....	46
Steel Wire Garment Hangers from China	49
Companies Willing to Evade U.S. AD/CV Duties on Steel Wire Garment Hangers from China	50
Steel Grating from China	53
Companies Willing to Evade U.S. AD/CV Duties on Steel Grating	54
Part II: Foreign Logistics Companies Willing to Evade U.S. AD/CV Duties	55
Eversky International Forwarding Agency	57
H&T International Logistics Ningbo Ltd	57
Ninbo Star International Freight Forwarding Co., Ltd	58
Pulinktrans China, Ltd	58
Shenzen Sunpower International Logistics, Ltd	59
Wintrans Logistics and Investment & Management Co., Ltd	59
Gateway Container Line Co., Ltd	60
Global Success International Transportation (Shenzen) Ltd	61
Dyna International Shipping Ltd	61

Table of Contents (cont'd)

Part II: Foreign Logistics Companies Willing to Evade U.S. AD/CV Duties (cont'd)	
Hanhen Shipping (China) Co., Ltd	62
Suzhou Yuncheng Ex/Im Co., Ltd	62
L'Assurex International Logistic Ltd.	63
Part III: Examples of Companies Advertising Illegal Transshipment Services on the Internet	65
References.....	79

Introduction

U.S. antidumping and countervailing duty (AD/CVD) laws form U.S. industry's protective backbone against injury from unfair trade. These laws provide American producers the ability to counter injurious unfair trade practices and ultimately allow for the imposition of additional duties on unfair imports.

Each year, U.S. companies collectively spend millions of dollars to initiate and litigate AD/CVD cases to keep illegally dumped or subsidized imports from entering the U.S. market and injuring them. Unfortunately, many U.S. producers believe that the evasion of America's unfair trade laws is increasingly pervasive. The circumvention of U.S. AD/CVD laws, either by foreign producers or importers, negatively affects industries throughout the United States, resulting in continued injury to U.S. industry, the loss of American jobs, and the loss of federal revenue.

Foreign suppliers subject to AD/CVD orders and their U.S. importers avoid paying AD/CV duties by a number of unscrupulous schemes, including illegal transshipment and falsified country of origin markings, undervalued invoices to pay less duty, and misclassification of goods. In sum, they cheat.

Staff set out to determine just how easy it is to find these trade cheats and determine the ease at which an importer could identify a foreign supplier willing to engage in circumvention schemes. In August 2010, staff created a fictitious company called AvisOne Traders, Inc. and set up a company profile on China's largest business-to-business e-commerce website, Alibaba.com, in order to find companies willing to cheat and evade AD/CVD orders. (AvisOne is an anagram for "evasion.")

The results are alarming and illustrative of how widespread the problem of duty evasion appears to be. In under two weeks and for as little as 30 minutes a day, one staff person, acting as a "purchasing manager" for AvisOne Traders, Inc., contacted roughly 120 companies through Alibaba.com and received 47 responses. Of these 47, this staff person received written confirmation from 10 Chinese companies that were willing to evade duties on five different products subject to U.S. AD/CVD orders. These products include uncovered innersprings units, lined paper school supplies, steel nails, natural bristle paint brushes, and light-walled rectangular pipe and tube. The AD/CVD orders on this merchandise, which represents just a small fraction of all AD/CVD orders currently in place, were put in place to protect over 120 businesses and 12,000 workers from unfairly traded imports.

This report is a compilation of information obtained by staff over a two-week period, and is organized into three parts. Part I presents e-mail correspondence between staff, acting under the auspices of AvisOne Traders, and Chinese producers. In a couple of additional examples, staff obtained from the counsel of U.S. industry non-solicited e-mails from Chinese producers offering to facilitate the evasion of AD/CVD orders. Part II presents a list of publically identified Chinese companies that advertise—in English—their ability to facilitate the evasion of AD/CVD laws. Part III includes snap shots of company websites that offer services designed to evade AD/CVD laws (in one instance, a website operated by the Chinese government itself and which advertises the services of a Chinese firm that facilitates evasion).

In the event that staff corresponded with a Chinese firm that is of interest to U.S. law enforcement, two versions of this report were prepared. A confidential version containing comprehensive information about the firms with which staff corresponded was provided to U.S. Customs and Border Patrol and Immigration and Customs Enforcement. This version, a public redacted version, was prepared in order to be shared with Members of Congress and their staff.

Part I:
Email Correspondence Showcasing Companies'
Willingness to Evade AD/CVD Orders

Certain Steel Nails from China

(DOC Case No. A-570-909)

Steel nails have a shaft length up to 12 inches, and include steel nails made of round wire and nails that are cut. They may be made of any type of steel, and have a variety of finishes. Nails are used in the construction of houses and used to make furniture and cabinets, among other applications.

Industry at a Glance:

- ⇒ Subject to AD order since August 1, 2008 (DOC)
- ⇒ Number of U.S. producers in 2007: 17
- ⇒ U.S. producers' U.S. shipments in 2007: \$220 million
- ⇒ U.S. employment of production and related workers in 2007: 791
- ⇒ U.S. production locations: Arkansas, California, Connecticut, Florida, Georgia, Illinois, Kentucky, Louisiana, Massachusetts, Missouri, Ohio, Pennsylvania, Rhode Island, Tennessee, Texas, Virginia, Wisconsin, West Virginia
- ⇒ Leading sources of U.S. imports (by value) in 2007: China, Korea, United Arab Emirates (USITCa, USITCb)

U.S. Production Locations of Steel Nails

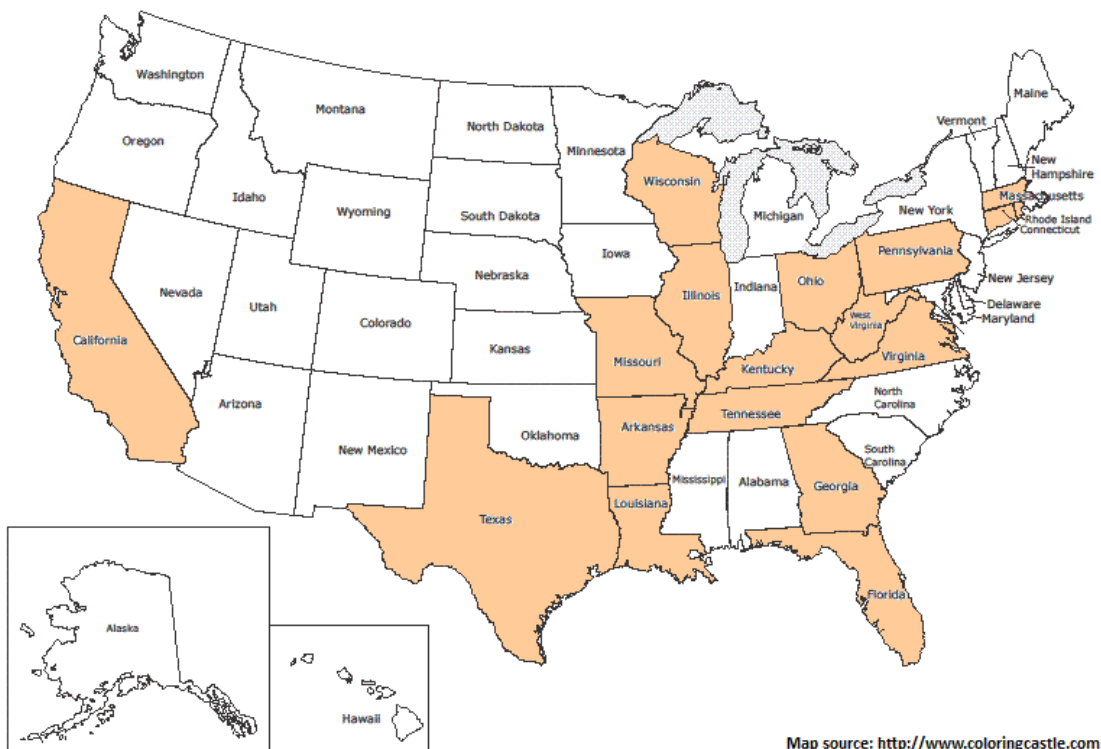

Companies Willing to Evade U.S. AD/CV Duties on Steel Nails

Staff, posing as a U.S. trading company, contacted these three Chinese steel nail producers/traders via Alibaba.com to inquire whether these companies could avoid paying duties on steel nails by illegal transshipment. In the first instance, Company A offered to transship when it was proposed by staff. In the second and third instances, Companies B and C directly proposed to illegally transship as a way to avoid paying duties. Below are transcripts of email correspondence documenting a willingness to evade AD/CVD orders (highlighted in red). Textboxes provide an explanation of the correspondence.

Company A

Product: Steel Nails
Country of origin: China
Means to evade duties: Illegal transshipment

From: feedback@service.alibaba.com

To: ***

Sent: Tues, August 31, 2010 5:12 AM

Subject: [avisonetraders@gmail.com]I want to buy the product you are selling on Alibaba.com

Dear ***,

You have received an inquiry from a free member on Alibaba.com. This is the first inquiry from this sender. Mr. Paul Union is interested in your company.

Buyer's Message

Subject: I want to buy the product you are selling on Alibaba.com.

Dear Sir:

We are a small trading company based in Oregon that supplies a diverse array of products to regional customers in the U.S. Pacific Northwest. We are seeking to diversify our supply chain in order to reduce costs. Can you provide a price list for your concrete steel nails? Also, are your steel nails subject to any U.S. antidumping duties?

Thank you,
Paul Union, Purchasing Manager
AvisOne Trading Company, Ltd.
Tel: (503) 583-4237
Email: AvisOneTraders@gmail.com

Explanation:

In this email, staff, acting as AvisOne Trading Co., initiates a product inquiry with Company A via Alibaba.com, China's largest e-commerce platform.

AvisOne Traders—Providing the Highest Quality Product at the Most Competitive Prices

Company A (cont'd)

From: ***

Sent: Tues, August 31, 2010 10:57 PM

To: "Paul Union" <avisonetraders@gmail.com>

Subject: Concrete nail

Hi, dear sirs:

Thanks for your enquiry about nails

To take this opportunity, we are very glad to introduce our company to you. We are the professional manufacturer and exporter with high reputation in TianJin city China, handling of nail products etc. Pls let us know the concrete nails specification of you required, we will quote you our lowest price on based of that.

We are looking forward to your early reply.

Best regards.,

From: "Paul Union" <avisonetraders@gmail.com>

Sent: Fri, September 3, 2010 8:36 AM

To: ***

Subject: Re: Concrete nail

Dear ***,

Thanks for your reply. Are you nails subject to any U.S. anti-dumping duties? If so, in your experience is there any way to avoid paying the duties?

Regards,

Paul

Explanation:

Company A describes its business and products. In the second email, staff asks if it is possible to avoid paying duties.

Company A (cont'd)

From: ***

Sent: Sun, September 5, 2010 10:47 PM

To: "Paul Union" <avisonetraders@gmail.com>

Subject: Re: Concrete nail

Hi, dear Paul:

Thanks for your email.

We have exported our products to U.S but the customer avoid the duties by themselves. So we do not know how can they avoid the duties. Sorry about that. But we can promise our products quality can meet your requirement.

Best regards.,

Explanation:

When asked if there is a way to avoid paying duties, Company A initially says no. However, when illegal transshipment is proposed as a way to avoid paying duties, Company A agrees, demonstrating at the very least that it is aware of the method. In this instance, Company A offers to ship product through a third country.

From: <avisonetraders@gmail.com>

Sent: Wed, September 8, 2010 7:48 AM

To: ***

Subject: Re: Concrete nail

Dear ***,

Thanks for your reply. [Would it be possible to transship the product through a third country and change the country of origin in order to avoid paying the duties?](#)

Best regards,

Paul Union

From: ***

Sent: Wed, September 8, 2010 11:12 PM

To: "Paul Union" <avisonetraders@gmail.com>

Subject: Re: Concrete nail

Dear Paul Union:

Thanks for your email.

[As you said, we can arrange the container shipping from Xingang to Malaysia, Bangladesh or Singapore. And the shipping agent can help us to issue the original certification, it will increase the cost but I think it must be lower than duties.](#)

Best regards.,

Company B

Product: Steel Nails
Country of origin: China
Means to evade duties: Illegal transshipment

Explanation:

In this email, staff, acting as AvisOne Trading Co., initiates a product inquiry with Company B via Alibaba.com, China's largest e-commerce platform.

From: feedback@service.alibaba.com

To: ***

Sent: Tues, August 31, 2010

Subject: [avisonetraders@gmail.com]Inquiry about your product

Dear ***,

You have received an inquiry from a free member on Alibaba.com. This is the first inquiry from this sender. Mr. Paul Union is interested in your company.

Buyer's Message

Subject: Inquiry about your product

Dear sir:

We are a small trading company based in Oregon that supplies a diverse array of products to regional customers in the U.S. Pacific Northwest. We are seeking to diversify our supply chain in order to reduce costs. Can you provide a price list for your concrete nails? Also, are your steel nails subject to any U.S. antidumping duties?

Thank you,

Paul Union, Purchasing Manager
AvisOne Trading Company, Ltd.
Tel: (503) 583-4237
Email: AvisOneTraders@gmail.com

AvisOne Trades - Providing the Highest Quality Product at the Most Competitive Prices

Company B (cont'd)

From: ***

Sent: Wed, September 1, 2010 3:02 AM

To: "Paul Union" <avisonetraders@gmail.com>

Subject: [avisonetraders@gmail.com]inquiry about your product

Dear Mr Paul Union,

How are you?

Our factory have produce the steel nail for 46years.

If you need the quotation,pls inform me the exact information include the diameter of the wire nail,length of the nail,surface treatment and also the packing demand.

Sincerely thanks and best regards!~

Yours ***

Explanation:

In the first email, Company B describes its business and products. In the second email, staff asks if it is possible to avoid paying duties. Company B responds that it already engages in illegal transshipment.

From: "Paul Union" <avisonetraders@gmail.com>

Sent: Fri, September 3, 2010 8:33 AM

To: ***

Subject: [avisonetraders@gmail.com]inquiry about your product

Dear ***

Thanks for your response. [Are your concrete nails subject to any U.S. anti-dumping duties? If so, in your experience is there any way to avoid paying the duties?](#)

Regards,

Paul

From: ***

Sent: Sat, September 4, 2010 1:29 AM

To: "Paul Union" <avisonetraders@gmail.com>

Subject: [avisonetraders@gmail.com]inquiry about your product

Dear Paul,

How are you?

Thank you for your e-mail. [we have export the concrete nails to Canada then to U.S.or other country then to U.S.](#) Our coil nail to U.S. do not need pay the duties.

[If you have any other company in Canada or Singapore?](#)

[Maybe it is better way to avoid paying the duties.](#)

Sincerely thanks and best regards!

Yours ***

Company C

Product: Steel Nails
Country of origin: China
Means to evade duties: Illegal transshipment

From: feedback@service.alibaba.com

To: ***

Sent: Tues, August 31, 2010 5:13 AM

Subject: [avisonetraders@gmail.com]Inquiry about your product

Explanation:

In this email, staff, acting as AvisOne Trading Co., initiates a product inquiry with Company C via Alibaba.com, China's largest e-commerce platform.

Dear ***,

You have received an inquiry from a free member on Alibaba.com. This is the first inquiry from this sender. Mr. Paul Union is interested in your company.

Buyer's Message

Subject: Inquiry about your product

Dear sir:

We are a small trading company based in Oregon that supplies a diverse array of products to regional customers in the U.S. Pacific Northwest. We are seeking to diversify our supply chain in order to reduce costs. Can you provide a price list for your concrete nails? Also, are your steel nails subject to any U.S. antidumping duties?

Thank you,

Paul Union, Purchasing Manager

AvisOne Trading Company, Ltd.

Tel: (503) 583-4237

Email: AvisOneTraders@gmail.com

AvisOne Trades - Providing the Highest Quality Product at the Most Competitive Prices

Company C (cont'd)

From: ***
Sent: Tue, August 31, 2010 10:23 PM
To: "Paul Union" <avisonetraders@gmail.com>
Subject: concrete steel nails

Dear sir ,

Good day ! I am *** ,from *** .
I got your message on alibaba .
so if you have any need ,please contact me .

Best regard .

From: "Paul Union" <avisonetraders@gmail.com>
Sent: Fri, September 3, 2010 8:37 AM
To: ***
Subject: Re: concrete steel nails

Thanks for your reply. I'm looking for concrete steel nails. Are these products subject to U.S. anti-dumping duties? [If so, is there any way to avoid paying the duties?](#)
Regards,
Paul

From: ***
Sent: Tue, August 31, 2010 10:23 PM
To: "Paul Union" <avisonetraders@gmail.com>
Subject: concrete steel nails

Dear sir ,
Yes . you want concrete steel nails?

[if you want to avoid paying the duties ,there is the way is send the goods to Malaysia and change a box ,then send to U.S](#)

so what do you think about it .

Best regard .

Explanation:

In this series of emails, staff ask Company C whether their nails are subject to U.S. antidumping duties and whether there is a way to avoid paying the duties. Company C proposes shipping product to Malaysia, changing containers, and then sending the new container with a different country of origin certificate to the United States.

Company C (cont'd)

From: "Paul Union" <avisonetraders@gmail.com>

Sent: Wed, September 8, 2010 7:19 AM

To: ***

Subject: Re: concrete steel nails

Thank you for your reply. So you can transship through Malaysia and change the country of origin to avoid paying the anti-dumping duties? Can your company do that?

Regards,

Paul

From: ***

Sent: Wed, September 8, 2010 8:43 PM

To: "Paul Union" <avisonetraders@gmail.com>

Subject: concrete steel nails

Dear sir ,

Thanks for your reply .

Yes .our company can do this .but in this way ,the cost will increase .

and just tell me your details product information .

Best regard .

Explanation:

Staff respond to Company C to confirm that it can transship product through Malaysia and change the country of origin of the product. Company C confirms its ability to illegally transship.

Certain Lined Paper School Supplies from China

(DOC Case No. A-570-901)

Lined paper school supplies include spiral-bound and wireless notebooks, hole-punched filled paper, and composition books. The paper is typically white and wide-ruled or college-ruled.

Industry at a Glance:

- ⇒ Subject to AD order since September 28, 2006 (DOC)
- ⇒ Number of U.S. producers in 2005: 13
- ⇒ U.S. producers' U.S. shipments in 2005: \$260 million
- ⇒ U.S. employment of production and related workers in 2005: 942
- ⇒ U.S. production locations: California, Georgia, Iowa, Massachusetts, New York, Pennsylvania, Tennessee, Texas, Wisconsin (USITCc, USITCd)

U.S. Production Locations of Lined Paper School Supplies

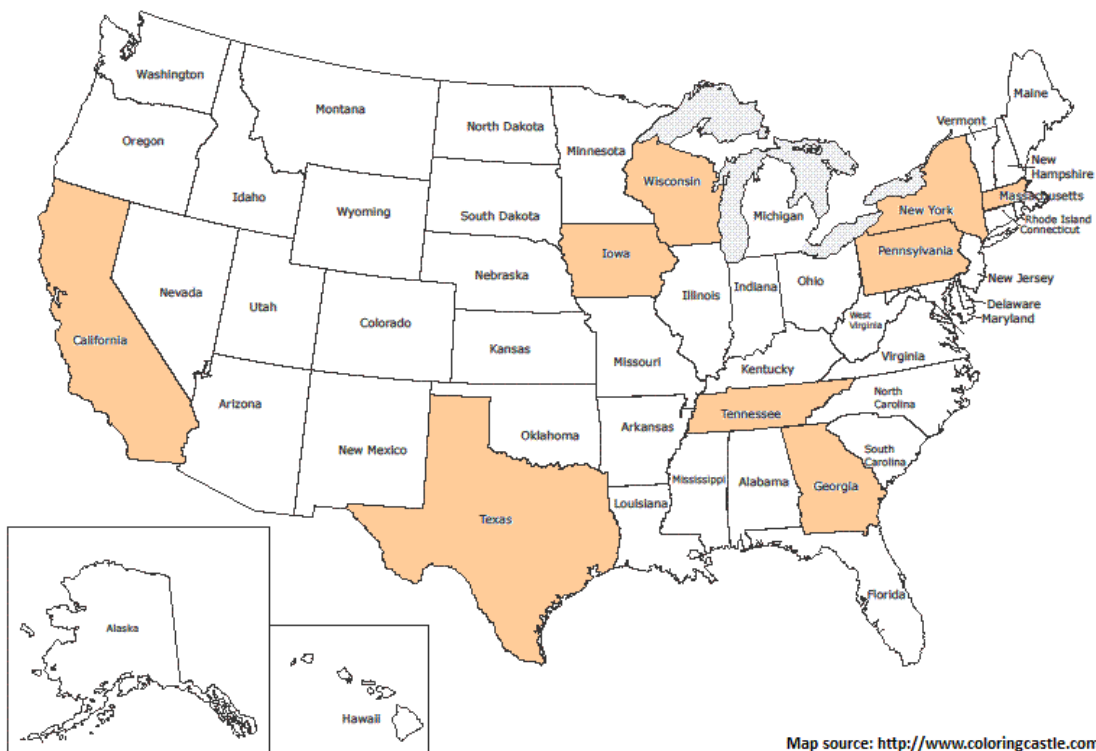

Companies Willing to Evade U.S. AD/CV Duties on Paper Products

Staff, posing as a U.S. trading company, contacted Companies D and E via Alibaba.com to inquire whether they could avoid paying duties on paper school supplies. In the first instance, Company D proposes illegal transshipment through Malaysia to avoid paying duties. In the second instance, Company E professes that it does not know how to avoid paying antidumping duties. However, it states that it deliberately undervalues the value of its products, which is another form of duty evasion. Below are transcripts of email correspondence documenting a willingness to evade AD/CVD orders (highlighted in red). Textboxes provide an explanation of the correspondence.

Company D

Product: Paper school supplies

Country of origin: China

Means to evade duties: Illegal transshipment through Malaysia

From: feedback@service.alibaba.com

To: ***

Sent: Wed, September 1, 2010

Subject: [avisonetraders@gmail.com]I want to buy the product you are selling on Alibaba.com

Dear ***,

You have received an inquiry from a free member on Alibaba.com. This is the first inquiry from this send. Mr. Paul Union is interested in your company.

Buyer's Message

Subject: Inquiry about your product

Dear Sir:

We are a small trading company based in Oregon that supplies a diverse array of products to regional customs in the U.S. Pacific Northwest. We are seeking to diversify our supply chain in order to reduce costs. Can you provide a price list for your lined paper products? Also, are your lined paper products subject to any U.S. antidumping duties?

Thank you,

Paul Union, Purchasing Manager

AvisOne Trading Company, Ltd.

Tel: (503) 583-4237

Email: AvisOneTraders@gmail.com

Explanation:

In this email, staff, acting as AvisOne Trading Co., initiates a product inquiry with Company D via Alibaba.com, China's largest e-commerce platform.

AvisOne Traders—Providing the Highest Quality Product at the Most Competitive Prices

Company D (cont'd)

From: ***

Sent: Tue, August 31, 2010 10:04 PM

To: "Paul Union" <avisonetraders@gmail.com>

Subject: Re: Inquiry about your product

Dear Paul,

It's please to get your enquiry from alibaba. Our factory ***, specializing in paper printing products, stationery notepad is our main product.

Herely I sending you our catalogue, pls check it, hop to meet your interesting. And customed item wel-come.

Actually, paper notebook is subjected to U.S. antidumping duties, because the our price is lower much than US market.

Looking forward to your soonly response.

Best regards,

From: "Paul Union" <avisonetraders@gmail.com>

Sent: Fri, September 3, 2010

To: ***

Subject: Re: Inquiry about your product

Dear ***,

Thank you for your response. [Is there any way to avoid paying the anti-dumping duties in your experience?](#)

Regards,
Paul

Explanation:

In the first email, Company D describes its business and products. In the second email, staff asks if it is possible to avoid paying duties.

Company D (cont'd)

From: ***

Sent: Wed., September 8, 2010 5:44 AM

To: "Paul Union" <avisonetraders@gmail.com>

Subject: Re: Inquiry about your product

Dear Paul,

Notebook of A4, A5, A6 size subjected to U.S. antidumping duties, other size no problem. [Solution is Shipping goods to Malaysia, transship to America to avoid paying the anti-dumping duties.](#)

How do you think about this solution?

Looking forward to hearing from you soon.

Thanks & Best regards,

From: "Paul Union" <avisonetraders@gmail.com.>

Sent: Wed., September 8, 2010 7:20 AM

Subject: Re: Inquiry about your product

Explanation:

In the first email, Company D offers to illegally ship product through Malaysia to avoid paying duties. Company D confirms that it can change the country of origin when asked by staff.

Dear ***

Thank you for your reply. [Can your company transship through Malaysia and change the country of origin in order to evade the anti-dumping duties?](#)

Best regards,

Paul Union

From: ***

Sent: Wed., September 8, 2010 7:31 AM

To: "Paul Union" <avisonetraders@gmail.com>

Subject: Re: Inquiry about your product

Dear Paul,

Thanks for your quick reply.

[yes, we can do that.](#) but first of all, you should tell me what kind of notebook are you seeking for your market, then I give you the CNF or CIF price, if price is suitable for your market, let's talk over further more.

Looking forward to your early reply with your inquiry.

Thanks & best regards,

Company E

Product: Paper school supplies

Country of origin: China

Means to evade duties: Undervaluation of invoice to pay less duty

From: feedback@service.alibaba.com

To: ***

Sent: Wed, September 1, 2010

Subject: [avisonetraders@gmail.com]Inquiry about your product(AdminGenerate)

Dear ***,

You have received an inquiry from a free member on Alibaba.com. This is the first inquiry from this send.

Mr. Paul Union is interested in your company.

Buyer's Message

Subject: Inquiry about your product

Dear Sir:

We are a small trading company based in Oregon that supplies a diverse array of products to regional customs in the U.S. Pacific Northwest. We are seeking to diversify our supply chain in order to reduce costs. Can you provide a price list for your lined paper products? Also, are your lined paper products subject to any U.S. antidumping duties?

Thank you,

Paul Union, Purchasing Manager

AvisOne Trading Company, Ltd.

Tel: (503) 583-4237

Email: AvisOneTraders@gmail.com

Explanation:

In this email, staff, acting as AvisOne Trading Co., initiates a product inquiry with Company E via Alibaba.com, China's largest e-commerce platform.

AvisOne Traders—Providing the Highest Quality Product at the Most Competitive Prices

Company E (cont'd)

From: ***
Sent: Wed, September 1, 2010 1:39 AM
To: "Paul Union" <avisonetraders@gmail.com>
Subject: Our product

Dear paul,
Let me introduce my company to you ,my company—*** is specialized in the manufacturer of various color printed paper cards, paper handbags, packing boxes, gift boxes, labels, tags, brochures, posters, packing materials and other related products for 20 years.Providing 'Quality Products, Excellent Service, Competitive Prices and Prompt Delivery', pls kindly browse our website:*** for free!
we can not only design and produce unique and fashion style products but also can make products according to your requirements, and your design is welcome
Attachment is our catalogue about some paper bags and boxes ,pls check it !
If you have some new inquiry ,pls contact us for free !
Await for your prompt reply !
Best regard !

Explanation:
In the first email, Company E describes its business and products. In the second email, staff asks if Company E's products are subject to antidumping duties and whether it is possible to avoid paying duties.

From: "Paul Union" <avisonetraders@gmail.com>
Sent: Fri, September 3, 2010 8:00 PM
To: ***
Subject: Re: Our product

Dear ***,
Thank you for your message. Are your paper notebooks subject to U.S. anti-dumping duties? In your experience, is there any way to avoid paying the anti-dumping duties?

Regards,
Paul

Company E (cont'd)

From: ***

Sent: Wed, September 15, 2010 4:26 AM

To: "Paul Union" <avisonetraders@gmail.com>

Subject: Our product

Dear Paul,

Thank you for your reply !

I am sorry so late reply you ! we have no experience to avoid paying the anti-dumping duties ,besides we make the commerical invoice , we write that the value of products is less than the factual cost .

Await for your prompt reply !

Best regard !

Explanation:

In this email, Company E states that it does not know how to avoid paying antidumping duties, but professes that it undervalues products on commercial invoices, which is a form of duty evasion.

Light-Walled Rectangular Pipe and Tube from China

(DOC Case No. A-570-501)

Carbon-quality welded light-walled rectangular pipe and tube is often referred to as ornamental or mechanical tubing. Principal uses include ornamental fencing, window guards and framing, and railings for construction and agricultural applications. It is also used in metal furniture, athletic equipment, and store display shelves.



Industry at a Glance:

- ⇒ Subject to AD/CVD orders since August 5, 2008 (DOC)
- ⇒ Number of U.S. producers in 2007: 28
- ⇒ U.S. producers' total shipments in 2007: \$513 million
- ⇒ U.S. employment of production and related workers in 2007: 973
- ⇒ U.S. production locations: Alabama, Arizona, Arkansas, California, Georgia, Illinois, Indiana, Kentucky, Michigan, Missouri, Mississippi, North Carolina, Ohio, Oregon, Pennsylvania, South Carolina, Tennessee, Texas, Wisconsin (USITCe, USITCf)

U.S. Production Locations of Light-Walled Rectangular Pipe and Tube

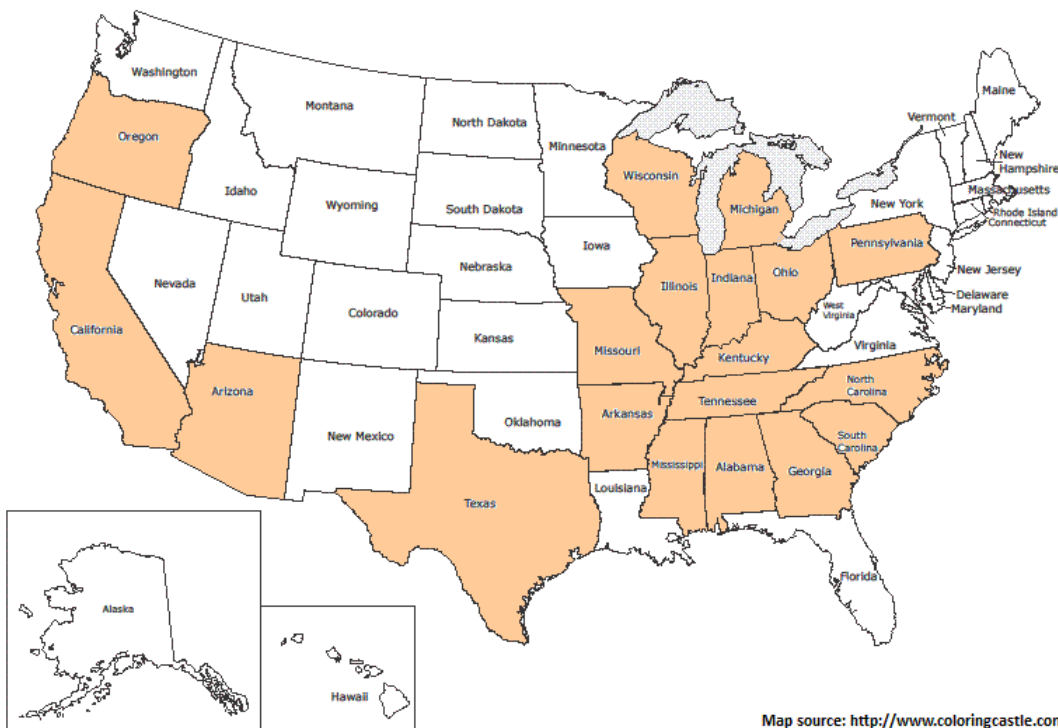

Companies Willing to Evade U.S. AD/CV Duties on Light-Walled Rectangular Pipe and Tube from China

Staff, posing as a U.S. trading company, contacted Company F via Alibaba.com to inquire whether its rectangular pipe and tube products are subject to U.S. antidumping duties and whether it could avoid paying such duties. Below is a transcript of email correspondence documenting a willingness to evade AD/CVD orders (highlighted in red). Textboxes provide an explanation of the correspondence.

Company F

Product: Pipe and tubular products

Country of origin: China

Means to evade duties: Illegal transshipment, also known as “entrepot” trade

From: feedback@service.alibaba.com

To: ***

Sent: Tues, August 31, 2010 5:52 AM

Subject: [avisonetraders@gmail.com]I want to buy the product you are selling on Alibaba.com

Dear ***:

You have received an inquiry from a free member on Alibaba.com. This is the first inquiry from this sender. Mr. Paul Union is interested in your company.

Buyer’s Message

Subject: I want to buy the product you are selling on Alibaba.com.

Dear Sir:

We are a small trading company based in Oregon that supplies a diverse array of products to regional customers in the U.S. Pacific Northwest. We are seeking to diversify our supply chain in order to reduce costs. Can you provide a price list for your rectangular tubular products? Also, are your light-walled rectangular tubular products subject to any U.S. antidumping duties?

Thank you,

Paul Union, Purchasing Manager

AvisOne Trading Company, Ltd.

Tel: (503) 583-4237

Email: AvisOneTraders@gmail.com

Explanation:

In this email, staff, acting as AvisOne Trading Co., initiates a product inquiry with Company F via Alibaba.com, China’s largest e-commerce platform.

Company F (cont'd)

From: ***
Sent: Fri, September 3, 2010 4:42 AM
To: "Paul Union" <avisonetraders@gmail.com>
Subject: To Paul Union

Dear Paul Union

HAPPY WEEKEND. and hope you received my quotation of *** rectangular pipes .

About the antidumping duties .I check up alots of information on the net .I still can't sure if rectangular tubular products subject to any U.S. antidumping duties. Many informations said that On May 3rd, the InternationalTradeCommission voted for Chinese steel 99.14% at the tax anti-dumping tariffs on imports.Are you clear about this ??

Hope you can tell me more about .

Yours

Explanation:

In the first email, Company F is not sure whether rectangular pipe and tube is subject to antidumping duties. In the second email, staff ask if it is possible to change the country of origin to avoid paying duties.

From: "Paul Union" <avisonetraders@gmail.com>
Sent: Fri, September 3, 2010 7:37 AM
To: ***
Subject: Re: To Paul Union

***,

Thank you for your message. I am not sure if rectangular tubing is subject to U.S. anti-dumping duties. Is there any way to avoid paying the anti-dumping duties? Would it be possible to modify the country of origin certificate?

Regards,
Paul

Company F (cont'd)

From: ***

Sent: Sat, September 4, 2010 6:38 AM

To: "Paul Union" <avisonetraders@gmail.com>

Subject: Re: To Paul Union

Dear Paul Union:

Thanks for your e-mail and have a good day .

I search a lot. [Yes ,there has a way to avoid paying the antidumping duties .It's entrepot trade. Export documents issued by the third countries so that facilitate you in yours customs clearance, avoid "anti-dumping duties"customs clearance.](#)

[Can you accept the export file as payment terms, at the same time to third countries as its export documents, can reduce clearance documents tariffs?](#)

And i've make certain about that rectangular tubular products subject to any U.S. antidumping duties.

Do you have any questions?

Yours Sincerely

Explanation:

Company F offers proposes "entrepot trade" another name for illegal transshipment. Company F states that it will help find a logistics company that can illegally transship.

From: "Paul Union" <avisonetraders@gmail.com>

Sent: Wed, September 8, 2010 7:45 AM

To: ***

Subject: Re: To Paul Union

Dear ***,

My apologies for my late reply. If I understand correctly, entrepot trade would involve transshipping the rectangular tubular products to another country in order to change the country of origin to avoid paying the anti-dumping duties on Chinese product? [Can your company do this?](#)

Best regards, Paul

From: ***

Sent: Thur, September 9, 2010 6:02 AM

To: "Paul Union" <avisonetraders@gmail.com>

Subject: Re: To Paul Union

Dear Paul Union:

How are you recently?

[Yes you are right .entrepot trade would involve transshipping the rectangular tubular products to another country in order to change the country of origin to avoid paying the anti-dumping duties on Chinese product.I find a company can do this.](#) But the products's price would be a little higher.

Uncovered Innersprings Units from China

(DOC Case No. A-570-928)

Uncovered innerspring units are composed of a series of individual metal springs joined together and used as the innerspring component in the manufacture of innerspring mattresses.

Industry at a Glance:

- ⇒ Subject to AD order since February 19, 2009 (DOC)
- ⇒ Number of U.S. producers in 2008: 8
- ⇒ U.S. producers' total shipments in 2007: \$539 million
- ⇒ U.S. employment of production and related workers in 2007: 2,970
- ⇒ U.S. production locations: Florida, Georgia, Kentucky, Michigan, Missouri, Mississippi, North Carolina, Texas, Wisconsin (USITCg, USITCh)

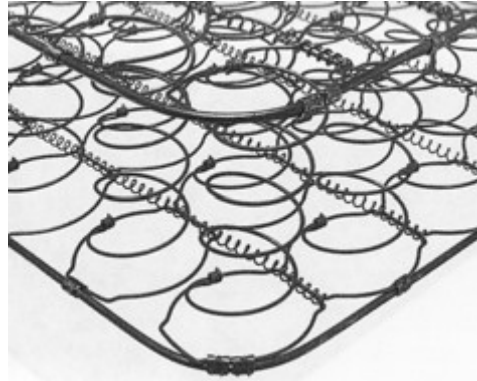

U.S. Production Locations of Uncovered Innerspring Units

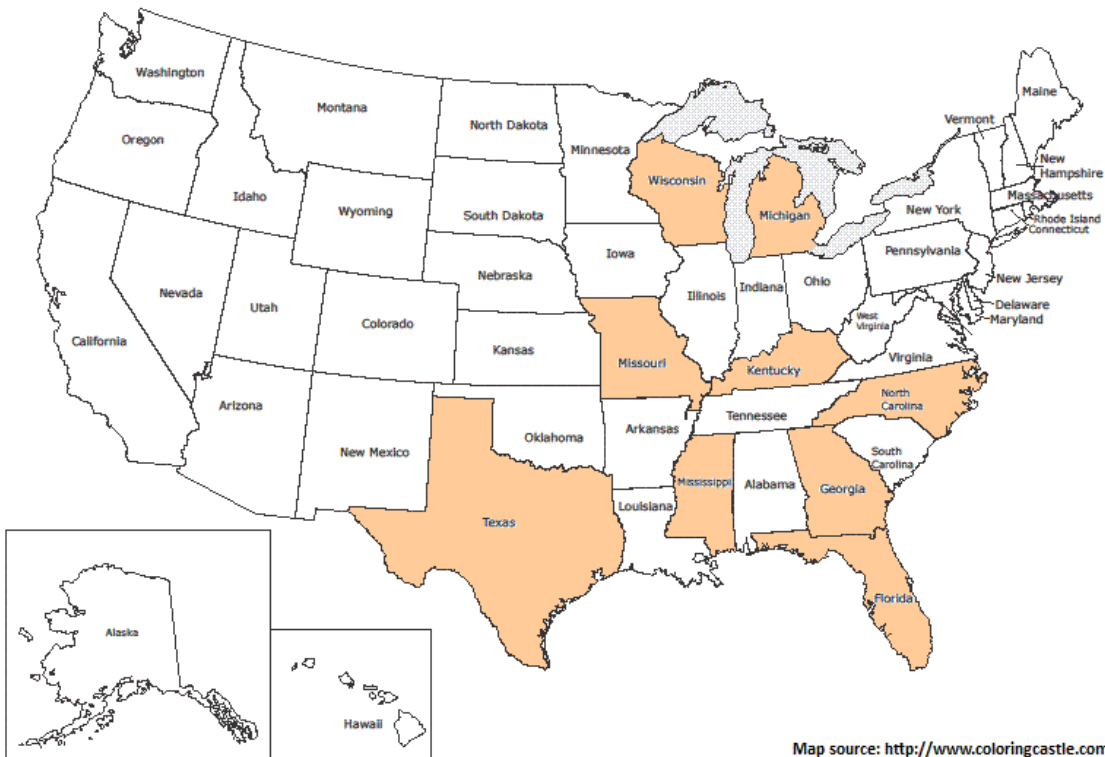

Companies Willing to Evade U.S. AD/CV Duties on Uncovered Innersprings Units

Staff, posing as a U.S. trading company, contacted Company G via Alibaba.com to inquire whether it could avoid paying duties on uncovered innersprings units. Company G proposed illegally transshipping product through a third country, or undertaking minor assembly in the United States to avoid paying duties. Below is a transcript of email correspondence documenting a willingness to evade AD/CVD orders (highlighted in red). Textboxes provide an explanation of the correspondence.

Company G

Product: Uncovered innersprings units

Country of origin: China

Means to evade duties: Illegal transshipment or minor assembly in United States

From: feedback@service.alibaba.com

To: ***

Sent: Tues, August 31, 2010

Subject: [avisonetraders@gmail.com]I want to buy the product you are selling on Alibaba.com

Dear ***

You have received an inquiry from a free member on Alibaba.com. This is the first inquiry from this sender. Mr. Paul Union is interested in your company.

Buyer's Message

Subject: I want to buy the product you are selling on Alibaba.com.

Dear Sir:

We are a small trading company based in Oregon that supplies a diverse array of products to regional customs in the U.S. Pacific Northwest. We are seeking to diversify our supply chain in order to reduce costs. Can you provide a price list for your innersprings units? Also, are your innersprings units subject to any U.S. antidumping duties?

Thank you,

Paul Union, Purchasing Manager

AvisOne Trading Company, Ltd.

Tel: (503) 583-4237

Email: AvisOneTraders@gmail.com

Explanation:

In this email, staff, acting as AvisOne Trading Co., initiates a product inquiry with Company G via Alibaba.com, China's largest e-commerce platform.

Company G (cont'd)

From: ***

Sent: Wed, September 1, 2010 3:17 AM

To: "Paul Union" <avisonetraders@gmail.com>

Subject: RE:FW [avisonetraders@gmail.com]I want to buy the product you are sel

Dear Paul

Thanks for your letter,and thanks for you are interested in our company.

We offer our price, as follows:

Wire :13g,(2.3mm). helical wire:17g (1.4mm) border 6g(4.88mm)

T type 36.5"*73.5"*6" 9*24 10.7Kgs FOB Tianjin US\$11.07/pc

F type 51.5"*73.5"*6" 13*24 14.9kgs FOB Tianjin US\$15.4/pc

Q type 58.5"*78.5"*6"15*26 18.3kgs FOB Tianjin US\$18.92/pc

K type 74.5"*78.5"*6" 18*26 22kgs FOB Tianjin US\$22.75/pc

Loading about 1250pcs in one 40' container. Gross weight 24Mt, Net weight :20Mt.

Yes ,our innerspring units is under U.S. antidumping duty, so we have two ways to export to your country: 1) Transit from the third part country, but would add about US\$3000/40'container fee for the third part country.

2) We could export the springs and the helical wire to your country, then you could make up them together by yourself.

What do you think, please let me know without any hesitation.

Thanks & Best Regards

Explanation:

In response to staff's inquiry, Company G proposes illegally transshipping innersprings through a third market to avoid paying duties, or proposes that the U.S. importer undertake minor assembly of the product in the United States.

Natural Bristle Paint Brushes from China

(DOC Case No. A-570-501)

Natural bristle paint brushes are made with natural (hog) bristle or other types of animal hair, and are used primarily to apply paint, stain, or varnish. Paint brushes come in several quality ranges and in a wide variety of widths and lengths.

Industry at a Glance:

- ⇒ Subject to AD order since February 14, 1986 (order terminated July 30, 2010 due to lack of interest) (DOC)
- ⇒ Number of U.S. producers in 2003: 12
- ⇒ U.S. producers' U.S. shipments in 2003: \$33 million
- ⇒ U.S. production locations: Florida, Illinois, Maryland, New Jersey, New York, Ohio, Oregon, Pennsylvania, Wisconsin (USITC)

U.S. Production Locations of Natural Bristle Paint Brushes



Companies Willing to Evade U.S. AD/CV Duties on Natural Bristle Paint Brushes from China

Staff, posing as a U.S. trading company, contacted Company H via Alibaba.com. Although the product is no longer subject to antidumping duties, Company H offered to ship product under a different company's name to avoid paying duties. The company stated that it could not directly change the country of origin, although it proposed illegally transshipping goods through Taiwan or Hong Kong as a way to avoid paying duties. Below is a transcript of email correspondence documenting a willingness to evade AD/CVD orders (highlighted in red). Textboxes provide an explanation of the correspondence.

Company H

Product: Natural Bristle Paint Brushes

Country of origin: China

Means to evade duties: Exporting under a different company name (e.g., shipping agent)

From: feedback@service.alibaba.com

To: ***

Sent: Tues, August 31, 2010 5:34 AM

Subject: [avisonetraders@gmail.com]I want to buy the product you are selling on Alibaba.com

Dear ***:

You have received an inquiry from a free member on Alibaba.com. This is the first inquiry from this sender. Mr. Paul Union is interested in your company.

Buyer's Message

Subject: I want to buy the product you are selling on Alibaba.com.

Dear Sir:

We are a small trading company based in Oregon that supplies a diverse array of products to regional customers in the U.S. Pacific Northwest. We are seeking to diversify our supply chain in order to reduce costs. Can you provide a price list for your natural bristle paint brushes? Also, are your paint brushes subject to any U.S. antidumping duties?

Thank you,

Paul Union, Purchasing Manager

AvisOne Trading Company, Ltd.

Tel: (503) 583-4237

Email: AvisOneTraders@gmail.com

Explanation:

In this email, staff, acting as AvisOne Trading Co., initiates a product inquiry with Company H via Alibaba.com, China's largest e-commerce platform.

Company H (cont'd)

From: ***

Sent: Tue, August 31, 2010 9:06 PM

To: "Paul Union" <avisonetraders@gmail.com>

Subject: Info of Natural bristle brush to Mr. Paul Union from China

Dear Mr Paul Union,

We are pleased to receive your following inquiry of natural bristle paint brush dated 31 August. Many thanks for it.

Yes, there has antidumping duties if we export to US market with natural bristle brush. Most of our US customers import paint roller and polyester brush from us. If you can use polyester brush instead of the bristle brush? Our polyester brush can hold much paints too as its split top end and the price is economic too.

Please let us know your comments about it and we will send you the details within one workday if we get your confirmation.

Best regards,

From: "Paul Union" <avisonetraders@gmail.com>

Sent: Fri, September 3, 2010 8:27 AM

To: ***

Subject: Re: Info of Natural bristle brush to Mr. Paul Union from China

Dear ***,

Thanks for your response. In your experience, is there any way to avoid paying the anti-dumping duties?

Regards,
Paul

Explanation:

Company H acknowledges that its natural bristle paint brushes are subject to antidumping duties and asks if AvisOne is willing to purchase a different kind of paint brush. In the second email, staff ask Company H if it is possible to avoid paying duties.

Company H (cont'd)

From: ***

Sent: Fri, September 3, 2010 9:27 PM

To: "Paul Union" <avisonetraders@gmail.com>

Subject: Re: Info of Natural bristle brush to Mr. Paul Union from China

Dear Paul,

Thanks for your message, maybe we can export in the name of agent's company that can avoid paying the anti-dumping duties.

Best regards,

Explanation:

Company H proposes exporting its products under a different name—in this case, the name of the shipping agent. Staff respond by asking if it possible also to change the country of origin certificate. Company H says that this is not possible, and proposes that AvisOne purchase brushes not subject to AD duties.

From: "Paul Union"

<avisonetraders@gmail.com>

Sent: Fri, September 3, 2010 8:27 AM

To: ***

Subject: Re: Info of Natural bristle brush to Mr. Paul Union from China

Dear ***

My apologies for responding late to your email. As you describe it, your company can ship product under a different name (in this case, the shipping agent) in order to avoid paying the anti-dumping duties? Is it possible that your company can change the country of origin as well?

Looking forward to your thoughts on this. Best regards, Paul

From: ***

Sent: Wed, September 8, 2010 9:36 PM

To: "Paul Union" <avisonetraders@gmail.com>

Subject: Re: Info of Natural bristle brush to Mr. Paul Union from China

Dear Paul Union,

Thanks for reply. I checked with the Exit Inspection and Quarantine, but the answer is "no" to change the origin country to other.

Now we don't have any better good thoughts about it, our most customers in America used the polyester material instead or just purchased the rollers. Can you use the polyester to instead the bristle?

Looking forward to your comments.

Best regards,

Company H (cont'd)

From: ***

Sent: Thur, September 9, 2010 2:00 AM

To: "Paul Union" <avisonetraders@gmail.com>

Subject: Re: Info of Natural bristle brush to Mr. Paul Union from China

Dear Paul Union,

[Do you know any companies in Taiwan or HK who can help you to export the brushes to your company? We send the brushes to them and then they export to you with their name.](#)

Explanation:

In this last email, Company H proposes exporting its brushes to companies in Taiwan or Hong Kong that can then re-export the brushes under those companies' names.

Oil Country Tubular Goods (OCTG) from China

(DOC Case No. C-570-944)

OCTG include carbon and alloy steel casing and tubing used in oil and gas wells. Casing is a circular pipe that serves as a structural retainer for the walls of the well. Tubing is installed inside the casing and is used to conduct the oil and gas to the surface.

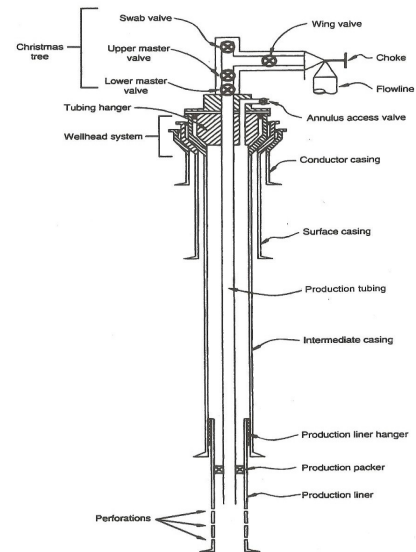

Industry at a Glance:

- ⇒ Subject to AD/CVD orders since May 21, 2010 (DOC)
- ⇒ Number of U.S. producers in 2009: 7
- ⇒ U.S. producers' U.S. shipments in 2008: \$6.2 billion
- ⇒ U.S. employment of production and related workers in 2008: 5,819
- ⇒ U.S. production locations: Alabama, Arkansas, Colorado, Iowa, Kentucky, Ohio, Oklahoma, Pennsylvania, Texas (USITCj, USITck)

U.S. Production Locations of OCTG

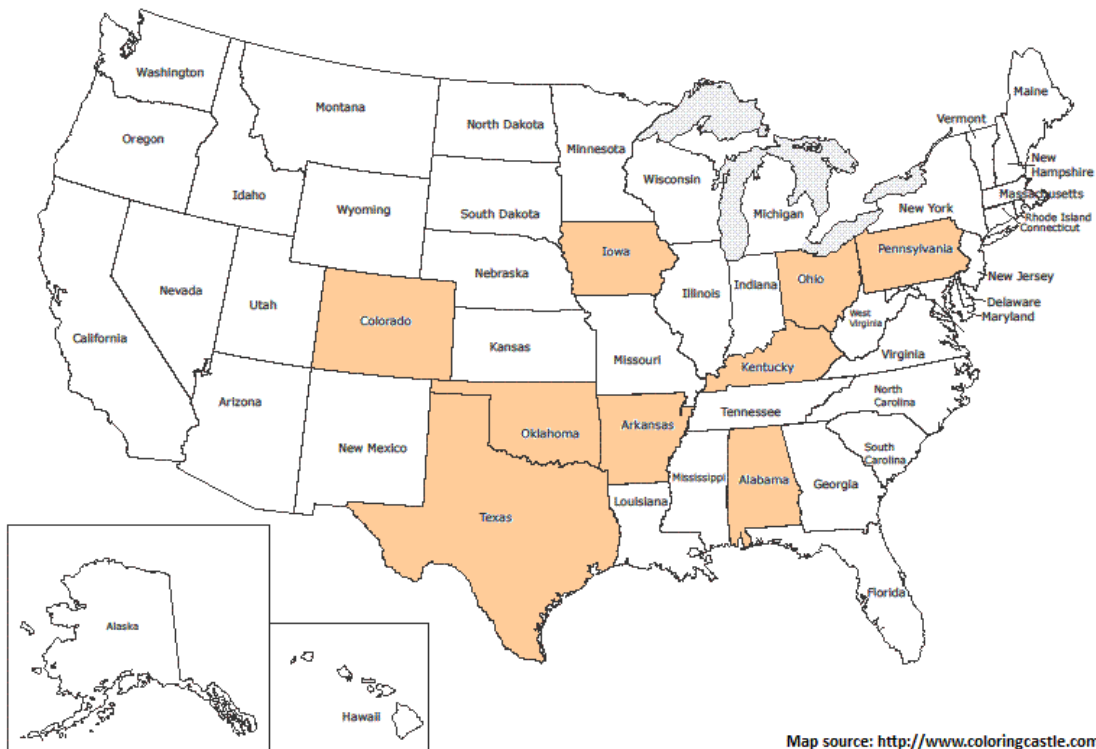

Companies Willing to Evade U.S. AD/CV Duties on OCTG from China

Company I is a trading company based in Turkey. It buys and sells Chinese-origin pipe products and changes the country of origin certificate to non-Chinese product. Below is a transcript of email correspondence provided to staff that document a willingness to evade AD/CVD orders on OCTG (highlighted in red). Textboxes provide an explanation of the correspondence.

Company I

Product: Oil Country Tubular Goods

Country of origin: China

Means to evade duties: Changing country of origin certificate

From: ***

Sent: Wed, August 11, 2010 3:45 AM

To: ***

Subject: DEAR *** PIPES FOR USA

DEAR ***

JUST MY BIG SPANISH PARTNER WHICH WE MADE WITH THEM OVER 10 MILLION USD PIPE ORDERS BEFORE SAID ,THEY CAN SHIP GOODS FROM VALENCIA SPAIN WITH EU ORIGIN CERTIFICATE .GOODS WILL BE PRODUCED IN CHINA& THEY WILL CHANGE ORIGIN IN SPAIN AND REEXPORT .THIS ONE OK? ALSO OUR SPAIN SELLER CAN OFFER UKRAIN OR EU ORIGIN .BUT SUGGEST ME TARGET PRICE . 4-YOUR MSN OR SKYPE ID ? MY SKYPE ID *** MY MSN *** MY MP ***

BEST REGARDS

From: ***

Sent: Wed, August 11, 2010 5:32 PM

To: ***

Subject: RE: DEAR *** PIPES FOR USA

***,

Explanation:

In this example, Company I, working with its business partners, is offering a U.S. importer Chinese-origin pipe with a false country of origin certificate. The U.S importer recognizes that this is illegal, and ceases communication with Company I.

THIS IS ILLEGAL! It is called "circumvention" and is subject to firm prison time.

We will end all discussion at this stage.

Company I (cont'd)

From: ***
Sent: Wed, August 11, 2010 9:46 AM
To: ***
Subject: DEAR *** PIPES FOR USA

DEAR ***
YOU ARE VEYR HARDWORKING PERSON.
IT MEANS IF THEY CHANGE ORIGIN WITH COATING,PAINTING,BEVELLING ETC FORMALLY ,ACCORDING TO EU LAW ALSO NOT POSSIBBLE TO USE CHINESE RAW MATERIAL ? SO I IGNORE IT.
2-ANY TARGET PRICE AS 0 ANTIDUMPING TAX ORIGINS ?

BEST REGARDS

Explanation:

Company I acknowledges that Chinese-origin pipe is subject to anti-dumping duties, but “ignores it.”

Diamond Sawblades from China

(DOC Case No. 570-900)

Diamond sawblades are circular cutting tools that have numerous functions and applications for cutting, ranging from cement, asphalt, marble, and tile, to masonry work such as brick and stone.



Industry at a Glance:

- ⇒ Subject to AD/CVD orders since January 23, 2009 (DOC)
- ⇒ Number of U.S. producers in 2005: 22
- ⇒ U.S. producers' U.S. shipments in 2004: \$121 million
- ⇒ U.S. employment of production and related workers: 480 (finished diamond sawblades only)
- ⇒ U.S. production locations: California, Georgia, Kansas, Massachusetts, Ohio, Pennsylvania, South Carolina, Tennessee, Texas, Utah, Washington (USITCI, USITCm)

U.S. Production Locations of Diamond Sawblades

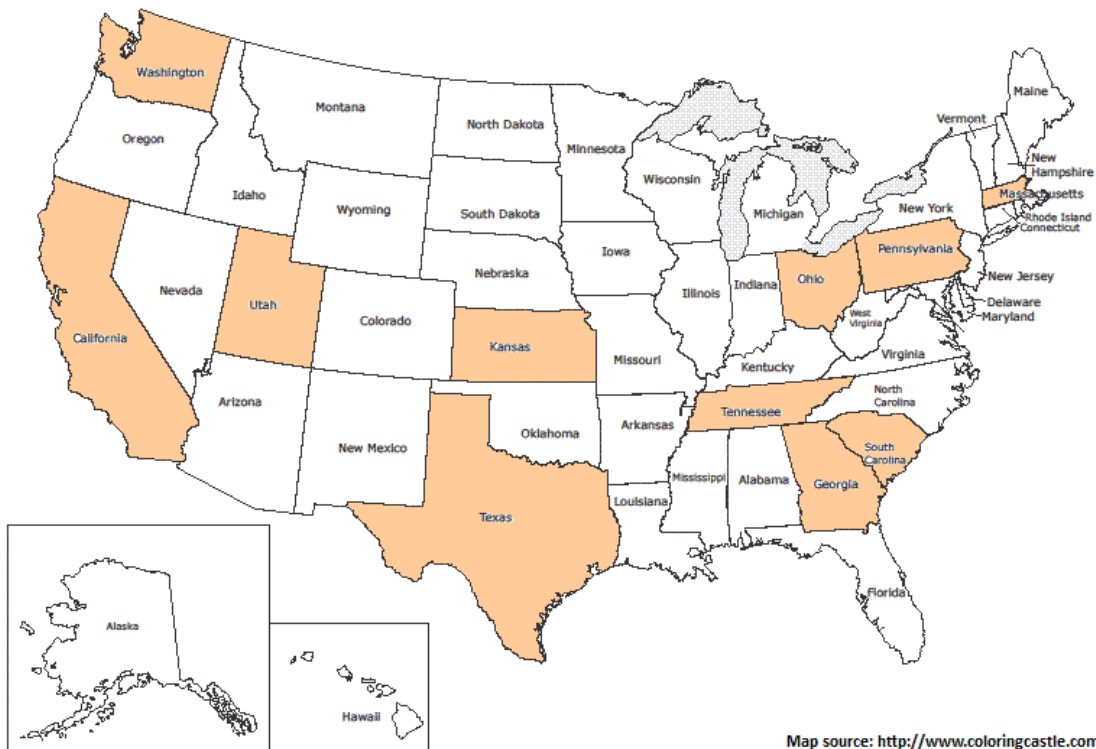

Map source: <http://www.coloringcastle.com>

Companies Willing to Evade U.S. AD/CV Duties on Diamond Sawblades from China

Companies J and K are Chinese trading companies that import and export diamond sawblades. Company J characterizes antidumping duties as a “political game,” while Company K admits that it engages in illegal transshipment to avoid paying antidumping duties. Below are transcripts of email correspondence documenting a willing to evade AD/CVD orders (highlighted in red). Textboxes provide an explanation of the correspondence.

Company J

Product: Diamond sawblades

Country of origin: China

Means to evade duties: Undervaluing invoices and misclassifying goods to avoid paying duties

From: ***

Sent: Thur, December 10, 2009 6:54 AM

To: Sales email account

Subject: Diamond tools and cutting machineries

Explanation:

In this email, Company J describes its business and products.

Dear Sir or Madam,

We are a Chinese company specialized in manufacturing various diamond tools which are widely used in Europe and USA.

Best ratio of quality to price could be achieved with the help of our diamond tools.

I'd like to offer you below tools for a reference in hope that we could be your competent and reliable partner in China.

Once got your requests, I'd like to send you our whole catalogue and pricelist.

Your prompt reply would be mostly appreciated.

Regards

Company J (cont'd)

From: ***

Sent: Thur, December 10, 2009 9:47 PM

To: ***

Subject: Re: Diamond tools and cutting machineries

[Are your saw blades subject to antidumping duties?](#)

From: ***

Sent: Thur, December 10, 2009

To: ***

Subject: Diamond tools and cutting machineries

Hi Sir,

Thanks for your prompt reply.

[I don't think it's a big problem for us. We have 3 solutions to help you out of this high duty---it's just a political game: anti-dumping duty.](#)

1. We can change the actual value of products in the Invoice a little bit.(as for small quantity such as trial order)
2. Our factory has responded to the lawsuit and will only be charged with 20% duty. When you order large quantity, it's no big deal.
3. We could ship the blades as the category of core.

Moreover, if you have any solutions, we would like to cooperate your actions from our side.

Regards

Explanation:

The U.S. importers asks if Company J's sawblades are subject to anti-dumping duties. Company J responds that antidumping is a "political game." Company J offers to undervalue the company invoice or misclassify the goods to avoid paying duties.

Company K

Product: Diamond sawblades

Country of origin: China

Means to evade duties: Illegal transshipment

From: ***

Sent: Thur, August 5, 2010 9:28 PM

To: ***

Subject: Re: Diamond Blades

Explanation:

Company K engages in illegal transshipment to avoid paying duties.

Hi ***,

Thanks for getting back to me.

[No, we are not affected by the anti-dumping as we can do trans-shipment.](#)

Regards,

Steel Wire Garment Hangers from China

(DOC Case No. A-570-918)

Steel wire garment hangers are produced primarily for use by the dry cleaning, industrial laundry, textile, and uniform rental industries.

Industry at a Glance:

- ⇒ Subject to AD order since October 6, 2008 (DOC)
- ⇒ Number of U.S. producers in 2007: 7
- ⇒ U.S. producers' U.S. shipments in 2007: \$12 million
- ⇒ U.S. employment of production and related workers: 139
- ⇒ U.S. production locations: Alabama, California, Illinois, Kentucky, New Jersey, Texas, Virginia, Wisconsin (USITCn, USITCo)



U.S. Production Locations of Steel Wire Garment Hangers



Map source: <http://www.coloringcastle.com>

Companies Willing to Evade U.S. AD/CV Duties on Steel Wire Garment Hangers from China

Companies L and M are Chinese metal hanger producers. In the first instance, Company L states that it can illegally transship through either Taiwan or Malaysia. In the second instance, Company M states that it can illegally transship via a third country for its “friends.” Below are transcripts of email correspondence provided to staff that document a willingness to evade AD/CVD orders (highlighted in red). Textboxes provide an explanation of the correspondence.

Company L

Product: Steel wire garment hangers
Country of origin: China
Means to evade duties: Illegal transshipment

From: ***
Sent: Thu, January 14, 2010 11:57:59 PM
To: ***
Subject: Re: ***

Attachment is our price list (FOB Shanghai), please find it. We have two ways to ship containers to US. One is from Taiwan, the transport charge is \$4200.00 per container. Another is from Malaysia, the transport charge is \$3200 per container, but the shipping date will be much longer than from Taiwan.

Please check the price, if it's ok, please let me know.

Best regards,

Explanation:

Company L offers to ship containers to the United States via Taiwan or Malaysia. Although not explicitly stated in this email, the motive for shipping through a third country is to avoid paying duties.

Company M

Product: Steel wire garment hangers
Country of origin: China
Means to evade duties: Illegal transshipment

From: ***

Sent: Friday, April 09, 2010 9:27 PM

To: ***

Subject: Re: RE: RE: Re: Re: Hanger Business

Yes, the tariff rate is high. However, we are not extinct because of it.

We keep a solution for our friends. It is benefit for us and our client. Both have made profit from it.

We do not know how much profit you can make from working with wells. In China, yes, wells' tariff rate is the lowest in china.

It is about 16%. He is the only one company for the first rank. Our factory is of the second rank.

However, we still alive. "Fact speaks louder." Our clients also make profit working with us.

For this kind of client, we usually ship via another country, through which you only need to pay about 3.5% or lower rate. So for this, usually, CIF, DDU or DDP is suitable for you.

If you do not know it properly, we can do DDP for you. That is, door to door service. Its procedure is very easy for you, just like we send a package through courier. Through it, we will send the hangers directly to your warehouse. In a word, it will save you much energy, and most important, a lot of money.

A trial order may make you know much about us.

We look forward to your reply, and hope we can cooperate with each in the near future.

Explanation:

Company M offers to illegally ship product through a third country to avoid paying duties. As stated by Company M, this service is offered to "our friends" and that illegal transshipment "is a benefit for us and our client."

Steel Grating from China

(DOC Case Nos. A-570-947 and C-570-948)

Steel grating (commonly referred to as bar grating), consists of two or more pieces of steel, including load-bearing pieces and cross pieces, joined by any assembly process, regardless of: (1) size or shape; (2) method of manufacture; (3) metallurgy (carbon, alloy, or stainless); (4) the profile of pieces; and (5) whether or not they are galvanized, painted, coated, clad or plated. Excluded from the scope are expanded metal grating, which is a single sheet or thin plate that has been slit and pulled; and safety plank grating, which is a single sheet or thin plate that has been pierced or cold formed.

Steel grating is designed to support and distribute the weight of objects. Common end uses include walkways, mezzanines, catwalks, fire escapes, stairways, and flooring.

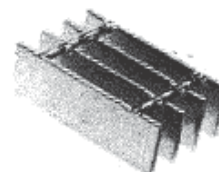

Industry at a Glance:

- ⇒ Subject to AD/CVD orders since July 23, 2010 (DOC)
- ⇒ Number of U.S. producers in 2009: 7
- ⇒ U.S. producers' U.S. shipments in 2009: \$162 million
- ⇒ U.S. employment of production and related workers in 2009: 518
- ⇒ U.S. production locations: Alabama, Illinois, Indiana, Ohio, Oklahoma, Mississippi, Pennsylvania, Texas, Utah (USITCp, USITCq)

U.S. Production Locations of Steel Grating

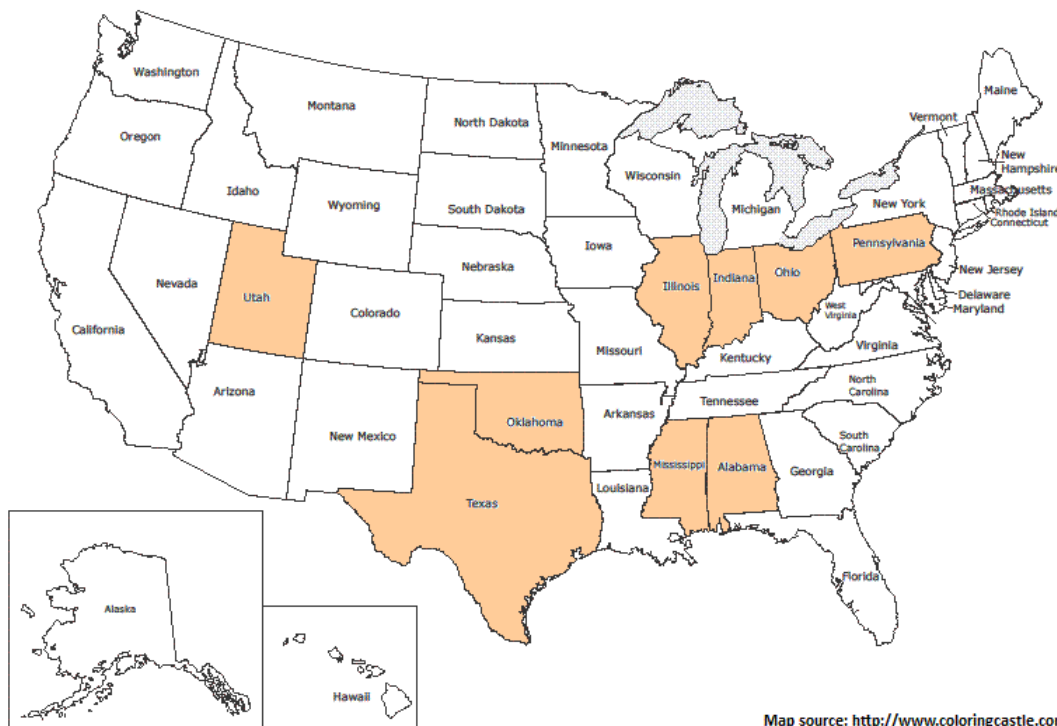

Companies Willing to Evade U.S. AD/CV Duties on Steel Grating

Company N is a Chinese steel grating producer. Below is an email provided to staff that documents the company's disregard for antidumping duty orders (highlighted in red).

Company N

Product: Steel grating
Country of origin: China
Means to evade duties: Illegal transshipment

From: ***
Sent: Mon, August 30, 2010 1:01 AM
Subject: ***

Below is the result of your feedback form. It was submitted by () on Monday, August 30, 2010 at 01:01:13

Name: ***
Company: ***
Address: ***
City: Ningbo
State: Zhejiang
ZIP: 315195
Country: China
Phone: ***
Email: ***
Comments: Dear Sir,

If you need the best steel grating with low-cost, why not contact us directly here?

[FYI, Antidumping duty is no problem for us.](#)

Submit: Send!

Part II:
Foreign Logistics Companies Willing to Evade U.S.
AD/CV Duties

Foreign Companies Willing to Evade U.S. AD/CV Duties

The following foreign logistics companies publically advertise services to avoid paying AD/CV duties and other import restrictions like import quotas. These firms advertise their services in both English and Chinese on websites like alibaba.com, China's largest e-commerce website that links buyers and sellers. Most evasion schemes involve illegal transshipment through a third country and falsified country of origin certificates for Chinese-origin product destined to the United States and other export markets. Many firms work with factories located in third countries to obtain authentic country of origin certificates for Chinese-origin product.

EverySky International Forwarding Agency

Address:	No. 455, Zhong Shan East Road, Ningbo, Zhejiang, China, 315400 Tel: +(86) 0574 2790 3558
Web:	http://www.everskyline.com/special1.php?id=6 http://www.alibaba.com/member/cn109650969.html http://www.made-in-china.com/showroom/infism/companyinfo/Eversky-International-Forwarding-Agency-Co-Ltd-.html
Company representative:	Mr. Zhao Hui Customer service representative: Mr. Cheng Tel: +(86) 0574 2787 9775 Email: jeffningbo@163.com
Other info:	Advertises illegal transshipment services to avoid paying AD/CV duties and other import restrictions. Prepares false country of origin certificates for Indonesia and Malaysia. Principal transit ports are Singapore and Port Klang, Malaysia.

H&T International Logistics Ningbo Ltd.

(subsidiary of Hualianton International Logistics Co., Ltd.)

Address:	Room 10-1, Yinyi Time Square, No. 8, Lengjing Street, Haishu District, Ningbo, China Tel: +(86) 574 8785 2330
Web:	http://www.hltnb.com http://blog.china.alibaba.com/blog/nb75520859/article/b0-i7726014.html
Other info:	Advertises illegal transshipment services to avoid paying AD/CV duties and other import restrictions. Prepares and provides false country of origin certificates and re-exports products through Port Klang, Malaysia. Company stipulates that domestic (Chinese) exporters must reach an understanding with the foreign importers regarding export documents (i.e. falsified country of origin certificates) and payment terms. Products illegally transshipped include fasteners, steel pipe, steel wire rope, steel wire hangers, aluminum products, clothing, shoes, candles, bearings, and citric acid.

Foreign Companies Willing to Evade U.S. AD/CV Duties (cont'd)

Ningbo Star International Freight Forwarding Co., Ltd

Address:	Also known as: Ningbo Richstar Freight Forwarding Agent Co., Ltd. High Storm International Freight Forwarding Co., Ltd. Win-Win International Freight Forwarding Co., Ltd. Sharp Gate Street, Ningbo City, Zhejiang Province, No. 58, City Renhe Center, 16-1, China Tel: +(86) 0574 8768 6088
Web:	http://www.richstarfreight.com http://www.sweiphone.eb80.com
Other info:	Advertises illegal transshipment services to avoid paying AD/CV duties and other import restrictions. Company uses different names when advertising transshipment services. Obtains authentic country of origin certificates from foreign factories despite product being of Chinese origin. Ships product from the Chinese ports of Dalian, Tianjin, Qingdao, Ningbo, Xiamen, and Shenzhen to Port Klang, Malaysia.
Illegal export procedures:	(1) Company's Malaysian branch acts as consignee in Malaysia. Removes first leg transportation manifest from China. (2) After cargo leaves China, customers provide copy of release of export documentation (e.g., first leg transportation, packing list, and invoice). (3) Malaysian branch in charge of procedures for changing containers and arranging booking for second leg transportation. (4) Before departure, Malaysia factories apply for certificates of origin for use for shipment of Chinese origin.

Pulinktrans China, Ltd.

Address:	Room 206, Goldenland Building, No. 773 Siping Road, Shanghai, China, 200092 Tel: +(86) 21 6107 6102
Web:	http://pulinktranschina-3141826.en.gongchang.com/ http://www.hifob.com/redirect.php?tid=22211&goto=lastpost
Other info:	Advertises illegal transshipment services to avoid paying AD/CV duties and other import restrictions. Provides authentic third-country country of origin certificates to clients, and can provide official authentication (by foreign country embassy) and notarized inspection report. Reportedly has cooperated closely with Ministries of Trade and Industry and Chambers of Commerce in Singapore, Malaysia, Indonesia, Thailand, Hong Kong, and the United Arab Emirates. Ports include Shanghai, Ningbo, Qingdao, Tianjin, Zhapu, Wenzhou, Shenzhen, and Hong Kong. Transshipment hubs include Malaysia and Thailand. Products illegally transshipped include fasteners, steel pipes, steel wire hangers, and clothing.

Foreign Companies Willing to Evade U.S. AD/CV Duties (cont'd)

Shenzen Sunpower Interntional Logistics, Ltd.

Address:	Room 2207, Gonglu Building, Block C, Yitai Centre, Dongmembei Road, Luohu District, Shenzhen, China, 518003 Tel: +(86) 0755 2519 1363 Email: sunpower@szsuperior.com
Web:	http://www.szsuperior.com/cn/home/index.asp http://www.ilazhu.cn/search/sell-service-9.html
Other info:	Company based in Shenzhen, China, but headquartered in Ipoh, Malaysia. Advertises illegal transshipment services to avoid paying AD/CV duties and other import restrictions. Provides various country of origin certificates depending on degree of customs inspection, production subject to AD/CV duties, and country of destination. Third-country certificates of origin provided include Taiwan, Malaysia, Indonesia, Bangladesh, Thailand, Vietnam, and Sri Lanka. All certificates of origin are provided by in-country factories. Company provides all documentation, customs declarations, factory inspection, and other relevant procedures.

Wintrans Logistics and Investment & Management Co., Ltd

Addresses:	Room 26A-D, Ocean Building, 268 Lujian Road, Xiamen, Fujian, China Tel: +(86) 592 806 5305 Email: info@wintrans.com.cm Shenzhen Wintrans Logistics Co., Ltd. Luohu District, Shenzhen City, Pacific Business Building, B1402, Shenzhen, Guangdong, China Shanghai Wintrans Branch Siping Road, 188 2108, Shanghai China
Web:	http://www.wintrans.com.cn/en/info/detail.asp?ID=5 http://cn.made-in-china.com/showroom/wintransalice/companyinfo/%E5%8E%A6%E9%97%A8%E9%80%9A%E6%B4%B2%E7%89%A9%E6%B5%81%E6%8A%95%E8%B5%84%E7%AE%A1%E7%90%86%E6%9C%89%E9%99%90%E5%85%AC%E5%8F%B8.html
Other info:	Advertises illegal transshipment services to avoid paying AD/CV duties and other import restrictions. Claims to work with business partners in Indonesia, Myanmar, and Malaysia that provide certificates of origin issued by factories located in those countries. Directs payment through Malaysia or Hong Kong. Products include steel pipes, apparel, shoes, ceramics, and furniture. Export markets include the United States, Canada, Mexico, Turkey, and Latin America.

Foreign Companies Willing to Evade U.S. AD/CV Duties (cont'd)

Gateway Container Line Co., Ltd.

Addresses:	<p>Gateway Container Line Co., Ltd. (Qingdao) B-1022, Yu Yuan Mansion, No. 75 West Hong Kong Road, Qingdao, China, 266071 Tel: +(86) 532 8197 8801</p> <p>Gateway Container Line Co., Ltd. (Tianjin) Room 2602, Twain building, Hangua Plaza, Dagunan Road, Hexi District, Tianjin, China, 300000</p> <p>Gateway Container Line Co., Ltd. (Shanghai) Room 2201, No. 1, Alley 258, Dongbaoxing Road, Shanghai, China, 200080 Tel: +(86) 21 6356 0173</p> <p>Room 612, Hesen Building, No. 1600 Yan'an Road (W), Shanghai, China, 200052 Tel: +(86) 21 5258 5515</p> <p>Gateway Container Line Co., Ltd. (Ningbo) 19 Floor, Unit B, Century Square, No. 118 Daliang Street, Ningbo, China, 315000 Tel: +(86) 574 8717 5858</p> <p>Gateway Container Line Co., Ltd. (Shenzhen) Room 1705, Building A, Huaguoshan Building, South Garden Road, Shekou, Shenzhen, China, 518067 Tel: +(86) 755 2680 5586</p>
Web:	http://www.gateway-group.cn/en/index.htm
Other info:	Advertises illegal transshipment services to avoid paying AD/CV duties and other import restrictions. Claims to provide services to both domestic (Chinese) exporters and foreign importers.

Foreign Companies Willing to Evade U.S. AD/CV Duties (cont'd)

Global Success International Transportation (Shenzhen) Ltd.

Address:	18F, Overseas Friendship Building, No. 12, Ying Chun Road, Luohu, Shenzhen, China, 510800 +(86) 755 8214 5368 Email: info@globalsourcing.com.cn
Web:	http://www.globesuccess.com.cn/en/index.asp http://www.ecplaza.net/tradeleads/seller/5605380/transshipment_project.html
Registration no:	Certified by China's Ministry of Commerce as a licensed non-vessel operating common carrier (NVOCC) (NVOCC#MOCNV 01254).
Other info:	Advertises illegal transshipment services to avoid paying AD/CV duties and other import restrictions. Transshipment hubs include Malaysia, Singapore, Indonesia, Bangladesh, the Philippines, and India. Third-country certificates of origin are issued for Chinese-origin product. Provides illegal transshipment services for the following products subject to U.S. AD/CVD orders: fasteners, threaded rod, steel hangers, locks, and wooden bedroom furniture. Also provides transshipment services for products subject to AD/CV duties in Europe, South America, and Turkey.

Dyna International Shipping Ltd.

Address:	Room 01-02, 16/F, Ginza International Building, Shennan Road, Shenzhen, Guangdong, China Tel: +(86) 755 2151 7557 Email: Shenzhen@dynaprc.com Other offices located in: Hong Kong, Guangzhou, Shanghai, Beihai, Huangpu, Nanhai, Foshan, Zhongshan, Wuhan, Kunming, Ningbo
Web:	http://www.dynaprc.com/english/index.asp http://www.hardware-wholesale.com/d-p115413722755560100-service-to-avoid-the-anti-dump-tax-import-from-china/
Other info:	Advertises illegal transshipment services to avoid paying AD/CV duties and other import restrictions. Transshipment hubs include Malaysia, Singapore, Thailand, and Indonesia with third-country certificates of origin. Advertises illegal transshipment services for Chinese products subject to AD/CV duties in the United States, Mexico, Colombia, Egypt, Turkey, and Europe.

Foreign Companies Willing to Evade U.S. AD/CV Duties (cont'd)

Hanhen Shipping (China) Co., Ltd.

Address:	A-1109, Jintian Building, Heping Road, Luohu, Shenzhen, China Tel: +(86) 0755 2556 5280
Web:	http://www.hanhen.com http://ca2.mofcom.gov.cn/aarticle/supplydemandofchina/supply/200905/20090506267440.html
Identification no:	China Tax ID: 440300769195249 United Nations Procurement Division Vendor ID: 09D00065 (Logistic Supplier)
Other info:	Advertises illegal transshipment services to avoid paying AD/CV duties and other import restrictions. Transshipment hubs include Singapore and Dubai. Country of origin certificates from Malaysia, Vietnam, Indonesia, and Bangladesh are issued for Chinese-origin products subject to AD/CVD orders. Advertises illegal transshipment services on the website of the Embassy of China in Canada.

Suzhou Yuncheng Ex/Im Co., Ltd.

Address:	No. 8-7 Shop, Shuixiang West Road, Meili Street, Songling Town, Wujiang, Jiangsu, China, 215200
Web:	http://yuncheng.en.alibaba.com/trustpass_profile.html http://www.alibaba.com/product-gs/269042075/Third_country_re_exports_seamless_steel.html
Company representative:	Mr. Yucheng Zhou
Business registration no.:	320584000113121
Issuing authority:	Suzhou City Wujiang Administration for Industry and Commerce
Issue date:	10/18/2007
Expiration date:	10/17/2017
Registered capital:	RMB 3,000,000
Other info:	Advertises illegal transshipment services to avoid paying AD/CV duties and other import restrictions. Advertises illegal transshipment services for seamless steel pipe and carbon steel fasteners, among other products.

Foreign Companies Willing to Evade U.S. AD/CV Duties (cont'd)

L'Assurex International Logistic Ltd.

Address:	Room 1207, Logistics Center, No. 1, Haitian Road, Huli, Xiamen, Fujian, China, 361000
Web:	http://www.lasurex.com http://www.alibaba.com/product-gs/282892965/sea_freight.html http://lasurex.en.alibaba.com/product/283189523-209769395/shipping_agency_in_china.html?tracelog=cgsotherproduct1
Company representative:	Mr. Liming Zheng
Registration no.:	350200200006505
Issuing authority:	Xiamen City Administration for Industry and Commerce
Issue date:	10/11/2007
Expiration date:	10/10/2027
Registered capital:	RMB 10,000,000
Other info:	Advertises illegal transshipment services on alibaba.com to avoid paying AD/CV duties and other import restrictions. Provides certificates of origin from Malaysia, Indonesia, and India for Chinese-origin product. Export markets include the United States, Venezuela, Brazil, Argentina, Europe, Jordan, Egypt.

**Part III:
Examples of Companies Advertising
Illegal Transshipment Services on the Internet**



The Economic and Commercial Counsellor's Office of the
Embassy of the People's Republic of China in Canada
中华人民共和国驻加拿大大使馆经济商务参赞处



[Commercial News](#) : [Bilateral Visits](#) : [Supply & Demand](#) : [Exhibition Info](#) : [About Us](#) : [Bilateral Cooperation](#) : [About China](#)
[China Law](#) : [Host Country](#) : [Laws of Host Country](#) : [Enquiry Online](#)

Current Location: [Homepage](#) > [Supply & Demand](#) > [Cooperation](#) > [Text](#)

Hanhen Shipping Company search for cooperation
Thursday, May 21, 2009 Posted: 21:12 BJT(12 GMT)
From: Hanhen Shipping Company Article type: Reproduced

Dear Sir/Madam,

I am writing to introduce you to Hanhen Shipping Company, which is based in Shenzhen on the east coast of China. We have taken the liberty of obtaining your details from the website and have made contact with a view to our respective organizations doing business together.

About Hanhen Shipping Company -- <http://www.hanhen.com/>
Logistics Partner of United Nations (VENDOR ID:09D00065)

My company has many years' experience in handling FCL/LCL/AIR/LAND RAIL shipments. We provide a wide range of shipping services, including arranging local contact with the shipper(MAERSK, YANGMING, EVERGREEN WANHAI, APL, COSCO and CSCL etc.), issuing of delivery documents, custom clearances etc. Especially we have a great advantage in rail transport from China to Russia/Middle Asia and large engineering machine transport. We operate according to international law and the laws of the Republic of China.

Key services
We enjoy long-term relationships with all of the main shipping lines and airlines. As your shipping and trading agent we can offer:

- Competitive freight rates and reliable service to and from most locations
- Rail transport from Tianjin/Shanghai/Lianyungang/Xiamen/Shenzhen to Russia/Middle Asia, etc.
- Industrial Projects Handling, Large Engineering Machine Transport (Such as crane, Heavy equipment etc.)
- Sea Export & Import Service (FCL/LCL/Consolidation)
- Air Freight Service
- Third Party Logistics
- Dangerous Cargo Handling
- Transshipment from China to Malaysia then to USA direct, to avoid quota and provide C/O of Malaysia.
- Handling of documents and cargos for FOB to CIF transactions, including switch MBL and HBL
- Assistance in application for Certificate of Origin, Form A, Legalisation of Docs, BV, SGS, as per instructions
- Diversion of Shipments
- Import to Shanghai/Ningbo/Shenzhen/Guangzhou
- Import from Hongkong to Mainland China under CEPA
- ATA/Personal Effects/Air Shipment
- Door to door delivery (Mainly USA, Canada, India, Europe)
- Warehouse consolidation services - 1. Receive cargo from more than one suppliers and loading container; and 2. Our warehouse can be used as your storage centre, you can put some cargo first, and sell them to your buyers in China

We have several offices in the India and other different countries of Asia

If you need any further information, pls kindly feel free to contact us! And I'm sorry if any inconvenienced that caused by this e-mail.

Best Regards!
kent chen

Hanhen Shipping (China) Co., Ltd
1109 Jintian Building, Heping Road,
Luohu, Shenzhen, China.
C: +86 0755 25565280
Fax: +86 0755 25561580
Cell: +86 13818671486
Skype: kentchenxujun
Msn: kent@hanhen.com
Email: kent@hanhen.com
<http://www.hanhen.com>
A leader of 3PL supplier in Asia

【Big medium-sized small】 【Print】 【Transmit】

Relative Articles:

- sunever company limited searches for cooperation 2009-04-27 21:28
- Limy Shuangling Plastic Co., Ltd searches for cooperation 2009-04-27 21:25
- Linsound Hearing Aid (Fuzhou) Co., Ltd. search for cooperation 2008-12-26 00:33
- Angel lighthouses factory search for cooperation 2008-12-26 00:15
- HANGZHOU MINGFA SEALING MATERIALS CO.,LTD search for cooperation 2008-12-26 00:13
- Canada, China to further enhance bilateral cooperation 2006-12-21 11:22

Release Comment: Pen Name: View: Comment

Copyright 2004, Ministry of Commerce of P.R. China
All Rights Reserved Please click the 125.0 and above to browse this site



Home > Contract Logistics > Triangular Trade

Out-Sourcing Logistics
International Distribution
Triangular Trade
Business Service

According to traders' demands in commercial interests and import tariff reduction, we provide BL switch for triangular trade, changing the CO, etc in order to protect the interests of traders and save tariff expenses.

1. Based on the principle of commercial confidentiality, we HANHEN work seriously as a intermediate part between processing manufacturers, traders and end-buyers and switch documents reasonably.
2. We use Singapore, Dubai to offer entrepot trade service and issue CO of Malaysia, Vietnam, Indonesia, Bangladesh in order to avoid tariff barriers.



Triangular Trade



Re-export Trade



Contact: sales@hanben.com | Global Contact: info@hanben.com
Tel: +86 755 25594780 Fax: +86 755 25561580/1680

By accessing and using this Web site, you agree to its [Legal Terms](#) and
2007, ©Hanben Shipping



Products Suppliers Buyers Buy on AliExpress.com

Search Products

About 909 results: Sea Freight (706)

Home > Products > Business Services > Logistics Services > Sea Freight (95839)

Language Options

There are 909 transshipment from 115 suppliers on Alibaba.com

Related Searches: [transshipment](#), [Wholesale transshipment](#)



See larger image: transshipment,the best way to avoid anti-dumping

Add to My Favorites

transshipment,the best way to avoid anti-dumping

Other products by Shipment Type: FCL and LCL

FOB Price: US \$2,000 - 8,000 / Carton [Negotiable](#)

Port: china

Minimum Order Quantity: 1 Carton/Cartons

Supply Ability: 100 Carton/Cartons per Day

Payment Terms: L/C,D/A,D/P,Western Union,MoneyGram

Ms. Helen Lu

Contact Supplier

Send a Message to this Supplier

Supplier Details

Asavvy Furniture Co., Ltd.

[Jiangsu, China (Mainland)]

Business Type:

Manufacturer, Trading Company,

Distributor/Wholesaler

Contact Details

Gold Supplier (1st Year)

A&V Checked

Online Showroom: 247 Products

Other Similar Products from this Supplier

[View this Supplier's Website](#)

Product Details Company Profile

Report Item Share

Quick Details

Place of Origin: Zhejiang China (Mainland)

Brand Name: eversky

Model Number: transshipment

Departure: china

Destination: all over the world

Route: EU

Carrier: Eversky international freight forward...

Departure Day: Monday

Transit Time (Days): 35

Shipment Type: FCL and LCL

Specifications

Are you looking for a way to avoid antidumping?

Transshipment may be the best way at present.

Nowadays, Transshipment is the best way to avoid anti-dumping duties. Now, we will tell you how it helps you to avoid anti-dumping and how it reduces your cost.

As we know, your country doesn't charge high tariffs for all the country but China. Now we can help you to provide the documents to your government certifying that the products are made of other low tariff countries instead of China.

How can we do it?

1st: We need to export those products(made in China) to other country (just as Malaysia). It is easy for us to do it and which just need cost your little money.

2nd: We will finish custom clearance for those cargos in Malaysia and then send it to our warehouse. Picking up those to re-load it to the new container(booking with Malaysia).

3rd: Finding a local factory to provide all the original documents to your country. And then export the products to your instruction Post.

After the operation of above, the original will be changed from China to Malaysia. You just need to pay the normal import duty.

Send your message to this supplier



Ms. Helen Lu

[View Supplier's Website](#)

[Add to My Contacts](#)

Enter your message here

-Enter between 20 to 3,000 characters, English only.

Send

Sourcing Products & Suppliers on Alibaba.com



Search Products

Enter the product you are looking for in the **Search Bar** and click **Search**



Contact Suppliers

Click **Contact Now** to send an inquiry or **Im online, Chat now** to chat online



Check Messages

Check quotes & messages from suppliers in your email inbox or Message Center

[Click here to learn more](#)

Related Products



transshipment,the best way to avoid anti-dumping
Are you looking for a way to avoid anti-dumping?
Transshipment may be the best way at present.

US \$ 2000-8000

Min. Order: 1 Carton/Cartons

[View more](#)

Search Products

Related Searches: [transshipment](#)

Want to find the right supplier? [Post a Request for Quotation now!](#)

[Email this page](#) [Bookmark this page](#) [Print this page](#)

Company Information Site Map Partnerships

Buy Sell My Alibaba Community Trade Shows Safety & Security Help Contact Us

Browse by: [Manufacturers](#) [Wholesalers](#) [China Gold Suppliers](#) [All Products](#) [Countries](#) [Importers](#) [Buying Leads](#) [China](#) [UK](#) [Australia](#)

Alibaba Group: [Alibaba.com](#) [Alibaba China](#) [Alibaba International](#) [AliExpress](#) [Alibaba Japan](#) [Taobao](#) [Alipay](#) [Yahoo! China](#) [Koubei.com](#) | [Alisoft](#)

[Product Listing Policy](#) [Intellectual Property Policy](#) [Infringement Claims](#) [Privacy Policy](#) [Terms of Use](#)

Copyright © 2008 Alibaba.com. All rights reserved.

Generated by AOA-HTML-Converter Trial Version

Welcome to Alibaba.com, Join Free | Sign In Buy Sell Community My Alibaba My Favorites Help

Alibaba.com
Global trade starts here.™

Products Suppliers Buyers Buy on AliExpress.com

About 51526 results: Sea Freight (23217), Air Freight (6378) Search Products

Home > Products > Business Services > Logistics Services > Sea Freight (95839) Language Options

There are 51526 shipping service in china from 1510 suppliers on Alibaba.com

Related Searches: [shipping service in china](#), [in floor china safes](#), [ship in the bottle](#), [ship in picture frame](#), [Wholesale shipping service in china](#)



lassurex.en.alibaba.com

See larger image: shipping service in china

Add to My Favorites

shipping service in china

FOB Price: [Get Latest Price](#)
Payment Terms: T/T

[Ms. rainnie ling](#) [Contact Supplier](#)
Send a Message to this Supplier

Supplier Details
L'assurex International Logistic Ltd.
[Fujian, China (Mainland)]
Business Type:
Trading Company, Agent
Contact Details
Gold Supplier [1st Year]
A&V Checked
Online Showroom: 39 Products
Other Similar Products from this Supplier
[View this Supplier's Website](#)

Product Details **Company Profile** Report Item Share

Quick Details

Place of Origin: Fujian China (Mainland)	Brand Name: L'Assurex	Model Number: Garment;Shoes;Small household ap...
Departure: China	Destination: Brazil	

Specifications

shipping service in china: Avoid high duty & tax or Anti-dumping duty Service: Malaysia/ Indones Form A/ CO & India CO/Bengal Fo

We have more than 4 years experience in this field, which mainly trade in consulting services in Certificate of Origin.

shipping service in china: Malaysia Form A/CO & Indonesia Form B/Form A & India Co/ Bengal Form A

to Europe /Turkey/USA/Venezuela/Brazil/Argentina/Jordon/Egypt etc...

Send your message to this supplier

[Ms. rainnie ling](#)
[View Supplier's Website](#)
[Add to My Contacts](#)

Enter your message here

-Enter between 20 to 3,000 characters, English only.

[Send](#)





Sourcing Products & Suppliers on Alibaba.com

[Search Products](#)
Enter the product you are looking for in the **Search Bar** and click **Search**

[Contact Suppliers](#)
Click **Contact Now** to send an inquiry or **I'm online, Chat now** to chat online

[Check Messages](#)
Check quotes & messages from suppliers in your email inbox or Message Center
[Click here to learn more](#)

Related Products

 <p>shipping service in china shipping service in china: Avoid high duty & tax or anti-dumping duty Service: Malaysia/ Indones Form A/ CO & India CO/Bengal Fo</p>	 <p>shipping agency in china shipping agency in china: Avoid high duty & tax or anti-dumping duty Service: Malaysia/ Indones Form A/ CO & India CO/Bengal F</p>	 <p>shipping agent from Oman to China With our agents support in Indonesia and skilled staffs, enables us to provide tailor-made and efficient service. Min. Order: 1 Cubic Meter/Cubic Meters</p>
 <p>shipping company ---shipping company from singapore to Japan --- SITC/SINOTRANS competitive rate</p>	View more	

Search Products [Search](#)

Related Searches: [shipping service in china](#) [in floor china safes](#) [ship in the bottle](#) [ship in picture frame](#)

Want to find the right supplier? [Post a Request for Quotation now!](#)

[Email this page](#) [Bookmark this page](#) [Print this page](#)

Company Information - Site Map - Partnerships
Buy - Sell - My Alibaba - Community - Trade Shows - Safety & Security - Help - Contact Us

Browse by: Manufacturers - Wholesalers - China Gold Suppliers - All Products - Countries - Importers - Buying Leads - China - UK - Australia
Alibaba Group: Alibaba.com | Alibaba China - Alibaba International - AliExpress - Alibaba Japan | Taobao | Alipay | Yahoo! China | Koubei.com | Alisoft
Product Listing Policy - Intellectual Property Policy and Infringement Claims - Privacy Policy - Terms of Use
Copyright © 1999-2014 Alibaba.com. All rights reserved.

China Trade Leads

[Home](#) > [China Service](#) > [China Commercial Service 3](#) > Service to Avoid the Anti-Dump Tax Import from China

Service to Avoid the Anti-Dump Tax Import from China

We are China dyna international freight forwarding company. We do the Ocean FCL & LCL, air service & train service ex-China ports to worldwide ports and any destination. You needn't concern about the anti-dumping tax or high duty import from China. We provide this kind of service to avoid the anti-dumping tax. To trans-ship from Malaysia/singapore/Thailand/Indonesia with (OC.: (BL, Packing list, Invoice, CO, form A).

1. Service to avoid this anti-dump tax import shoes from China to Europe/Mexico/USA.
2. Service to avoid this anti-dump tax import garment from China to Europe/Mexico/USA/Colombia.
3. Service to avoid this anti-dump tax import Door Locks from China to Egypt/South America.
4. Service to avoid this anti-dump tax import metal Silicon from China to Europe.
5. Service to avoid this anti-dump tax import metal valve from China to Mexico.
6. Service to avoid this anti-dump tax import ceramic tile & PVC from China to Turkey/Egypt.
7. Service to avoid this anti-dump tax import Bike fittings from China to Europe.
8. Service to avoid this anti-dump tax import Energy-saving lighting from China to Europe.

Pls do not hesitate to contact me if need this kind of service.

[Bill of Lading Forms](#) www.JJKeller.com

Comply with DOT & EPA Regs. Hazmat, Straight Bill of Lading & Supplies.

[Freight Forwarding](#) www.FreightForwardIntl.com

Reliability, Service, Low Prices Across the Globe
- Air, Land, & Sea

[Freight Forwarding](#) myFreight.com

Use our free freight service quotes and compare dozens of companies.

[Free Sourcing White Paper](#) www.tradecard.com

10 ways to counter rising costs of labor and materials overseas



Ads by Google

[Shenzhen Commercial Service](#) [China Commercial Service](#) [Exporters Shenzhen](#) [Exporters Shenzhen](#) [Exporters 13 Dyna International Shipping Limited](#)

[Sourcing Services For African Clients](#) [Google Left Rankings](#) [QC Inspection Service](#) [Agent Service \(China\)](#) [Organic Production Certification](#) [New Sample/Product Design \(BTM-2\)](#) [Private Detective](#) [Commercial Investigation](#) [Outward Processing Arrangements](#) [Final Random Inspection \(FRI\)](#) [Bill of Lading - Packing Machine](#) [China Presence](#) [Export Agent In Yiwu China](#) [Project Coordination Services](#) [Acting As Drop Shipper And Offer Drop Shipping Service](#) [Website Design/Web Application/Flash Design](#) [LFGB Certification](#)

© 2008-2009 China Trade Leads - Chinese B2B Import & Export Directory

Generated by ACA HTML Converter Trial Version

Source: <http://china-trade-leads.com/china-service/china-commercial-service-3/service-to-avoid-the-anti-dump-tax-import-from-china>



[Buy Now](#)

[Sell Now](#)

[Services](#)

[My EC21](#)

[Home](#) > [Buy Now](#) > [Entrepot Logistics Shanghai](#)

[> HOME](#)

[Company Profile](#)

Contact us

Entrepot Logistics Shangha
i
[China]

Address:
road siping 356 Shanghai
Shanghai China

Phone:
86-21-55159001

Contact name:
kirk

[Inquire Now >](#)

Entrepot Logistics Shanghai

About Us

[Inquire Now >](#)

We provide via 3rd country bonded area logistics with CO, FORM A to evade anti-dumping duties in your country. MSN entrepot-logistics (at) hotmail.com

Transshipment is the best way to evade anti-dumping.

Now, more and more countries are restricting or anti-dumping import Made in China products, espacially Turkey and Mexico are restricting the fabrics which made in china is the severest. The transshipment is the only way to avoid it.

We can help you to avoid anti-dumping if ...

[Read More](#)

Company Profile

[More](#)

- Company Name:** Entrepot Logistics Shanghai
- Country/Territory:** China
- Business Type:** Others
- Registration Date:** 2010/04/01 (Year/Month/Date)
- Buyer / Seller in EC21:** Both
- Keyword** fabrics, laminate floor, yarns, polyester

[Industrial Supplies](#) Industrial Distribution Group available on-line and in stock! [www.idg-corp.com](#)

[Contract Manufacturer](#) SMT, Through-Hole, Mixed, RoHS. 50 years experience. Service focus. [www.qcirouits.com](#)

[TradeTang China Wholesale](#) Made in China Products Distribution for Wholesale,Drop Shipping,Retail [www.TradeT.](#)

Ads by Google

Share : [Like](#) | [Tweet](#) 0 | [Delicious](#) | [Google](#) | [Favorite](#) | [My EC21](#) | [Email this page](#) | [TOP](#)

[Home](#) | [Buy Now](#) | [Sell Now](#) | [Services](#) | [My EC21](#) | [Help](#) | [Community](#)

[About Us](#) | [Advertise with Us](#) | [Agent Program](#) | [Site Map](#) | [Contact Us](#) | [Country Search](#) | [Premium Suppliers](#)

[Terms & Conditions](#) | [Privacy Policy](#) | [Online Trading Risks](#) | [EC21 Mobile Web](#)

[中文](#) | [繁體](#) | [한국어](#) | [日本語](#) | [Español](#) | [русский](#) | [Français](#) | [Deutsch](#)

Hot Products: [A](#) | [B](#) | [C](#) | [D](#) | [E](#) | [F](#) | [G](#) | [H](#) | [I](#) | [J](#) | [K](#) | [L](#) | [M](#) | [N](#) | [O](#) | [P](#) | [Q](#) | [R](#) | [S](#) | [T](#) | [U](#) | [V](#) | [W](#) | [X](#) | [Y](#) | [Z](#)

Copyright (c)1997-2010 EC21 Inc. All Rights Reserved. [EC21 in Korean](#) | [Chinese](#)

Generated by ACA HTML Converter Trial Version

Source: <http://united5.en.ec21.com>



 **Member Login**

Username or e-mail: *

Password: *

» [Create New Account](#)
» [Request New Password](#)

Transshipment, Help You Avoid Anti-Dumping Duties

Posted Wed, 08/11/2010 - 02:31 by infism
Expires: 08/31/2011

[Ads by Google](#) [Air Freight](#) [Sea Freight](#) [China Import](#) [China EC](#) [Import Goods](#)

Company: EVERSKEY INTERNATIONAL FORWARDING AGENCY CO., LTD

Website: [Http://Www.re-Export.net](http://Www.re-Export.net)

Description:

Are you looking for a way to avoid antidumping? Transshipment may be the best way at present.

Now we will show you how it helps you to avoid anti-dumping and how it reduces your cost.

As we know, your country doesn't charge high tariffs for all the country but China. Now we can help you to provide the documents to your government certifying that the products are made of other low tariff countries instead of China.

How can we do it?

1st: We need to export those products(made in China) to other country (just as Malaysia). It is easy for us to do it and which just need cost your little money.

2nd: We will finish custom clearance for those cargos in Malaysia and then send it to our warehouse. Picking up those to re-load it to the new container(booking with Malaysia).

3rd: Finding a local factory to provide all the original documents to your country. And then export the products to your instruction Post.

After the operation of above, the original will be changed from China to Malaysia. You just need to pay the normal import duty.

We are experienced in it for many years, and we are confident that we have the ability to help you to lower the import tariff. You are welcomed to contact us if you are fond of our service

Tags: transshipment, freight forwarder, sea freight, air freight, avoid anti-dumping

[Ads by Google](#) [Export China](#) [Sanli China](#) [China Co LTD](#) [Import Duty](#) [Export Goods](#)

Freight Forwarding

Use our free freight service quotes and compare dozens of companies.
myFreight.com

Freight Forwarding

Reliability, Service, Low Prices Across the Globe - Air, Land, & Sea
www.FreightForwardIntl.com

Freight Audit and Payment

Freight Bill auditing and payment Logistics Management Professionals
www.nvisionglobal.com

Freight Clearance Services

Call Us for a Nationwide Customs Broker With 30 Years Experience.
www.RealPages.com/GuyLichtenstein



Ads by Google



Gateway
Global Standard Service

GATEWAY CONTAINER LINE CO.,LTD

[Set Home](#) | [Favorites](#) | [Chinese Version](#)

[Home](#) | [Introduction](#) | [News](#) | [Cargo track](#) | [Shipping know](#) | [Branch](#) | [Contact us](#)

welcome to Gateway

Cargo track

Select

- Shanghai Ningbo
- Qindao Dalian
- Tianjin Xiamen
- Shenzhen Guangzhou

Ningbo Advertisir ▾

Branch introduced

Our Business:

Best tailor made sea, air, land and multimodal shipping solutions for clients, issue authorized all way Bill of Lading.

FCL Export Business:

Take the advantage of preferential contracts with HANJIN, CSCL and COSCO, we're able to provide requested cabinet space during peak seasons as well as long term stable price for Europe lines to ports Hamburg, Felixstowe, Rotterdam and Antwerp. For Mid-east Persian Gulf lines to ports Dubai, Abu Dhabi, B. Abbas, Bahrain, Dammam, Doha, Kuwait and Muscat. Simultaneously, we also offered competitive rates.

Bulk Cargo Export Business:

Being export large machinery and autos in the manner of bulk cargo for long time, we've built up close relations with bulk carrier companies and bulk cargo ports.

Import Business:

Depend on a professional team, we have been offering flawless import distribution services for years, customers world wide are new able to trace their cargos on ship via our website. Our client-oriented employees are available for any queries even during national holidays.

Air Cargo Business:

Our competitive rate and services is to Southeast Asia, Australia and Europe.

Special Services: Third Country Transshipment

The fact that import tax for same product varies in Customs of different countries makes reasonably avoid anti-dumping possible. Since we are founded, count on our reliable official intelligence and mature experience, we have been providing One-Stop Third Country Transshipment logistic service for domestic exporters and foreign importers, effectively helped our clients lower the cost, increase the profit and the competitiveness.

Generated by ACA HTML Converter Trial Version

Source: <http://www.gateway-group.cn/en/related.htm>

Home > Buy Now > Metals > Screws, Bolts, Nuts, Pins, Springs > View Trade Leads

All **Selling Leads** TradeMall Products Companies Buyers Electronic Parts Showroom

Real Time machinery - petrol agent wa

Export Compliance System Export Customs Compliance Software Request A Free Product Demo Today! [www.kew.com](#)
Fasteners: All Types Over 75,000 Items Listed on Website Buy Online or Call 1-800-222-0324. [www.MutualScrew.com](#)
Steel Buildings on Sale 70% Off on Clearance Inventory Limited Time Only, Free Quote Here! [www.SteelMasterUSA.com](#)

Ads by Google

TRANSHIPMENT PROJECT TO AVOID ANTIDUMPING TAX
Posting Date : Feb 20, 2009 GMT

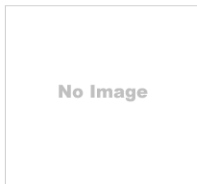

Company: Globe Success International Transportation (Shenzhen) LTD
Membership: Free Member since Feb 20, 2009
Country/Region: China
Address: 18FL, Oversea Friendship Building, 12#, Yingchun Road, Luohu, shenzhen, Guangdong, China 510800
Contact: Ms. ANNA LEE
Phone: 86-755-8214-5702
Fax: 86-755-8230-7954
Mobile: 86-1371-4045-400
Tags: TO AVOID ANTIDUMPING TAX

Contact Now Add to Cart BOOKMARK

Freight Forwarding

Reliability, Service, Low Prices
Across the Globe - Air, Land, & Sea

[www.FreightForwardIntl.com](#)

Export Compliance System

Export Customs Compliance Software Request A Free Product Demo Today!

[www.kewill.com](#)

Fasteners: All Types

Over 75,000 Items Listed on Website Buy Online or Call 1-800-222-0324.

[www.MutualScrew.com](#)

Ads by Google

TRANSHIPMENT PROJECT TO AVOID ANTIDUMPING TAX

1) In order to save the antidumping tax when import the goods from China, here we would like to provide the service to China shippers and oversea consignees to arrange their goods via the third countries' port (this can be in Malaysia, Singapore, Indonesia, Bangladesh, Philippine, India, etc.) and issue the third country document to ship the goods to the final destination country.

A. antidumping goods export from China to USA:
a. fastener, thread rod, steel hangers, locks, bed room wooden furniture, etc.

B. antidumping goods export from China to Europe:
a. fastener, thread rod, leather shoes, bicycle and energy saving lamp, etc.

C. Antidumping goods export from China to South America:
a. Hardware, garment, bicycle, tyre, etc.

D. antidumping goods export from China to Turkey:
a. Ironing board, garment, shoes, tile, ceramic etc.

E. other antidumping goods, just keep us inquired

2) Any further inquiry, just let us know below information, then we will provide our best project for the routine way and advice for yr choosing.

- A. goods name (if any H.S CODE, it is better)
- B. quantity
- C. destination
- D. shpt ready date—if any
- E. yr special requirement—if any(such as transiting country, document, time, etc.)

Appreciated for yr further contact.

Best regards!

Anna Lee

Globe Success International Transportation (Shenzhen) LTD

SHENZHEN OFFICE

TEL: 86-755-82145702

FAX: 86-755-82307954

MOBILE: 86-13714045400

18FL, Oversea Friendship Building, No.12 Ying Chun Rd, Shenzhen, China.

Optional Information

- HS Code : 7318 Screws, Bolts, Nuts, Coach Screws, Screw Hocks, Rivets, of Iron or Steel

Wholesale Dropshipping

Want To Be An Online Retailer? We Offer

Access To 1,000,000 Products.

[www.Doba.com](#)

TradeTang China Wholesale

We Offer Connections to 3,000,000 China

Manufacturers, Top Quality

[www.TradeTang.com](#)

Air Export Service

Reliable worldwide logistics airfreight

solutions.

[www.supflr.com](#)

Polymer Manufacturing

WV: Home To Innovative Co-location

Opportunities for Polymer Companies

[www.chemicalsw.com](#)



Ads by Google

Contact Information

Ms. ANNA LEE
(transhipment dept.)

Contact Now

Company : Globe Success International Transportation (Shenzhen) LTD

Address : 18FL, Oversea Friendship Building, 12#, Yingchun Road, Luohu, shenzhen, Guangdong, China

Zip /Postal : 510800

Telephone : 86-755-8214-5702

Fax : 86-755-8230-7954

Mobile : 86-1371-4045-400

Email this page BOOKMARK



Henan JinShui
Cable
Group Co., Ltd.



[Home](#) | [Product Directory](#) | [Offer Board](#) | [Virtual Office](#) | [Buyer Service](#) | [Info Centre](#) | [Audited Suppliers](#)

By Product All Categories [Advanced Search](#)

Home » Member Showroom

- Member Showroom
- Member Home
- Company Info
- Product List
- Offer List
- Contact Details
- Index
- Send Inquiry

- ★ Add to Company Favorites
- 👤 Recommend to friends

Pulinktrans China Ltd.

Our service: Avoid antidumping transshipment; Customs clearance in Russia.

1. Sea, air, rail transportation, import and export booking, customs clearance, warehousing, storage and other traditional services.
2. To circumvent anti-dumping, a third country of transit transport, while providing many products such as certificates of origin and embassy endorsement.
3. To provide Russia, ... [[Click for Details](#)]

Member Info

Business Type: Service, Agent, Other
 Number of Employees: 5 ~ 50
 Business Scope: Service
 Member Since: 2009
 Last Sign In Date: 2010-09-29

Product List

Product Name	Update Date
Export Via A-Third-Country Against The Anti-Dumping Policy	2010-07-05
Customs Clearance in Russia or Ukraine	2010-01-18

📌 **Related Category:** [Service](#) » [Commercial Service](#)

Contact Details



Company Name: Pulinktrans China Ltd.
Company Address: Room 206, Goldenland Building, No. 773 Siping Rd, Shanghai, P. R. China
City/Town: Shanghai
Province/State: Shanghai
Country/Region: China
Zip/Postal Code: 200092

Phone Number:

Fax Number:

Please [sign in](#) to view contact details

Homepage:

Mobile:

Contact Person (Department):

Mr. Zhang(Re-Export Department)

Click here to send inquiry

[Disclaimer](#)

For Buyers:

[Search China Products / Suppliers / Manufacturers](#)
[Post Offer to Buy](#)
[Quick Products](#)
[Search & Index](#)

For China Manufacturers and Suppliers:

[Add your Products](#)
[Search Buyers](#)
[Promotion - Spotlight Exhibits](#)
[Recommended Products](#)

For Global Manufacturers and Suppliers:

[Post Offer to Sell](#)
[Recommended Offers](#)

Home > Products > Minerals & Metallurgy > Steel > **Steel Pipes (947195)**

Language Options

There are **681013** **seamless steel pipe** from **1733** suppliers on Alibaba.com

Related Searches: [seamless steel pipe](#), [seamless carbon steel pipe](#), [seamless stainless steel pipe](#), [seamless steel tube](#), [Wholesale seamless steel pipe](#)



See larger image: Third-country re-exports seamless steel pipe,magnet,carbon steel fasteners

Add to My Favorites

Third-country re-exports seamless steel pipe,magnet,carbon steel fasteners

FOB Price: [Get Latest Price](#)

Ms. lianheng SH

Contact Supplier

Send a Message to this Supplier

Supplier Details

Suzhou Yuncheng Ex/Im Co., Ltd.

[Jiangsu, China (Mainland)]

Business Type:

Manufacturer, Trading Company

Contact Details

Gold Supplier (2nd Year)

A&V Checked

Online Showroom: 244 Products

Other Similar Products from this Supplier

[View this Supplier's Website](#)

Product Details

Company Profile

Report item Share

Quick Details

Type: Other

Specifications

Third-country re-exports to reasonably circumvent anti-dumping duty

We are a Shanghai international integrated logistics company. Third-country re-exports to reasonably circumvent anti-dumping duty is one of our speciality business. Deeply & greatly, we are favored and trusted by companies or enterprise whose products are hindered to export. For this reason, if your product has met with anti-dumping and other trade barriers, we can provide advice and assistance, we are confident that our professional operational level will help to you. Hot Products: seamless steel pipe, carbon steel fasteners, alnico and several dozens of products. Consultation Tel.:021-65079700

Send your message to this supplier



Ms. lianheng SH

[View Supplier's Website](#)

[Add to My Contacts](#)

Enter your message here

-Enter between 20 to 3,000 characters, English only.

Send

Sourcing Products & Suppliers on Alibaba.com



Search Products

Enter the product you are looking for in the **Search Bar** and click **Search**



Contact Suppliers

Click **Contact Now** to send an inquiry or **I'm online, Chat now** to chat online



Check Messages

Check quotes & messages from suppliers in your email inbox or Message Center

[Click here to learn more](#)

Related Products



Third-country re-exports seamless steel pipe,magnet,carbon steel fasteners

Third-country re-exports to reasonably circumvent anti-dumping duty

[View more](#)

Search Products

Search

Related Searches: [seamless steel pipe](#) [seamless carbon steel pipe](#) [seamless stainless steel pipe](#) [seamless steel tube](#)

Want to find the right supplier? [Post a Request for Quotation now!](#)

[View More Related Items](#)

[Email this page](#)

[Bookmark this page](#)

[Print this page](#)

Company Information - Site Map - Partnerships

Buy - Sell - My Alibaba - Community - Trade Shows - Safety & Security - Help - Contact Us

Browse by: Manufacturers - Wholesalers - China Gold Suppliers - All Products - Countries - Importers - Buying Leads - China - UK - Australia
Alibaba Group: Alibaba.com | Alibaba China | Alibaba International | AliExpress | Alibaba Japan | Taobao | Alipay | Yahoo! China | Koubei.com | Alisoft
Product Listing Policy - Intellectual Property Policy and Infringement Claims - Privacy Policy - Terms of Use

Copyright © 2000-2012 Alibaba.com. All rights reserved. Generated by ACA HTML Converter Trial Version.



Jiangsu Dongfang Hydraulic Co., Ltd.
http://www.jyyeya.com



- [Home](#)
- [Product Directory](#)
- [Offer Board](#)
- [Virtual Office](#)
- [Buyer Service](#)
- [Info Centre](#)
- [Audited Suppliers](#)

By Product
All Categories

[Advanced Search](#)

[Home](#) > [Member Showroom](#)

- Member Showroom**
- Member Home**
- [Company Info](#)
- [Contact Details](#)
- [Send Inquiry](#)
- [Add to Company Favorites](#)
- [Recommend to friends](#)

Shanghai Wintrans Branch

We are a professional forwarder who can provide this entrepot services via Malaysia or Indonesia.

This will help you to evade high anti-dumping duties and anti-subsidies at your country, so that we may have chance to re-establish our business.

The general procedure can be operated as below steps:

1. Transport from China ports to Malaysia, Port Klang / Singapore
2. Transport from ... [[Click for Details](#)]

Member Info

Business Type: Trade, Service
Number of Employees: 5 ~ 50
Business Scope: Transportation
Member Since: 2010
Last Sign In Date: 2010-04-21

Contact Details



Company Name: Shanghai Wintrans Branch
Company Address: Siping Road 188 2108, Shanghai, China
City/Town: Shanghai
Province/State: Shanghai
Country/Region: China
Zip/Postal Code:

Phone Number:
Fax Number: Please [sign in](#) to view contact details
Homepage:
Mobile:

Contact Person (Department): Mr. Henry



[Disclaimer](#)

For Buyers:

[Search China Products / Suppliers / Manufacturers](#)
[Post Offer to Buy](#)
[Quick Products](#)
[Search & Index](#)

For China Manufacturers and Suppliers:

[Add your Products](#)
[Search Buyers](#)
[Promotion - Spotlight Exhibits](#)
[Recommended Products](#)

For Global Manufacturers and Suppliers:

[Post Offer to Sell](#)
[Recommended Offers](#)

[Home](#) - [Promotion](#) - [FAQ](#) - [Help](#) - [Privacy Policy](#) - [Terms & Conditions](#) - [Declaration](#)

[日本語](#) [Français](#) [Español](#) [Deutsch](#) [Português](#) [Italiano](#) [Русский язык](#) [한국어판](#) [عربية منصة](#) [भारतीय](#)

Our Products: [Made-in-China.com](#) - [MIC Mobile](#) - [中国制造网中文站](#) - [领动 \(Leadong\)](#) - [商聚园 \(Shangjiuyuan\)](#) - [爱聘才 \(Ipincai\)](#) - [焦点视界 \(Focus Vision\)](#)

Copyright © 2010 Focus Technology Co., Ltd. All rights reserved.

Your use of this website is subject to, and constitutes acknowledgement and acceptance of our [Terms & Conditions](#).

Generated by ACA HTML Converter Trial Version

Source: <http://www.made-in-china.com/showroom/1987126>

References

- U.S. Department of Commerce (DOC). AD/CVD Orders in Effect (excel spread sheet), updated August 12, 2010, available at <http://info.usitc.gov/oinv/sunset.nsf/AllDocID/96DAF5A6C0C5290985256A0A004DEE7D?OpenDocument>.
- U.S. International Trade Commission (USITC) (USITCa). *Certain Steel Nails from China*. Inv. No. 731-TA-1114 (Final), July 2008.
- USITCb. "Certain Steel Nails from China Injure U.S. Industry, Says ITC." Press release, July 9, 2008.
- USITCc. *Certain Lined Paper School Supplies from China, India, and Indonesia*. Inv. Nos. 701-TA-442-443 and 731-TA-1095-1097 (Final), September 6, 2006.
- USITCd. "Certain Lined Paper School Supplies from China, India, and Indonesia Injure U.S. Industry, Says ITC." Press Release, September 6, 2006.
- USITCe. *Light-Walled Rectangular Pipe and Tube from Turkey*. Inv. No. 731-TA-1121 (Final), May 2008.
- USITCf. "Light-Walled Rectangular Pipe and Tube from China, Korea, and Mexico Injure U.S. Industry, Says ITC." Press Release, July 17, 2008.
- USITCg. *Uncovered Innersprings Units from South Africa and Vietnam*. Inv. Nos. 731-TA-1141-1142 (Final), December 2008.
- USITCh. "Uncovered Innerspring Units from China Injure U.S. Industry, Says ITC." Press release, January 2009.
- USITCi. *Natural Bristle Paint Brushes from China*. Inv. No. 731-TA-244 (Second Review), November 2004.
- USITCj. *Oil Country Tubular Goods from China*. Inv. No. 701-TA-463 (Final), January 2010.
- USITCk. "Certain Oil Country Tubular Goods from China Injure U.S. Industry, says USITC." Press Release, December 30, 2009.
- USITCl. *Diamond Sawblades and Parts Thereof from China and Korea*. Inv. Nos. 731-TA-1092 and 1093 (Final), July 2006.
- USITCm. "Diamond Sawblades and Parts Thereof from China and Korea Do Not Injure U.S. Industry, Says USITC." Press Release, June 19, 2006.
- USITCn. *Steel Wire Garment Hangers from China*. Inv. No. 731-TA-1123 (Final), September 2008.
- USITCo. "Steel Wire Garment Hangers from China Injure U.S. Industry, Says USITC." Press Release, September 11, 2008.

References

USITCp. *Certain Steel Grating from China*. Inv. Nos. 701-TA-465 and 731-TA-1161 (Final), July 2010.

USITCq. "Certain Steel Grating from China Injures U.S. Industry, Says USITC." Press release, June 24, 2010.

